

RESCUE

READY

MATILDA SHIELDS

‘THE RNLI SAW A **100%**
INCREASE OF BEACH USERS IN
THE FIRST WEEK OF SEPTMEBER
COMPARED TO 2019’

-RNLI 2020

IMAGE: HAILEY HEATEN

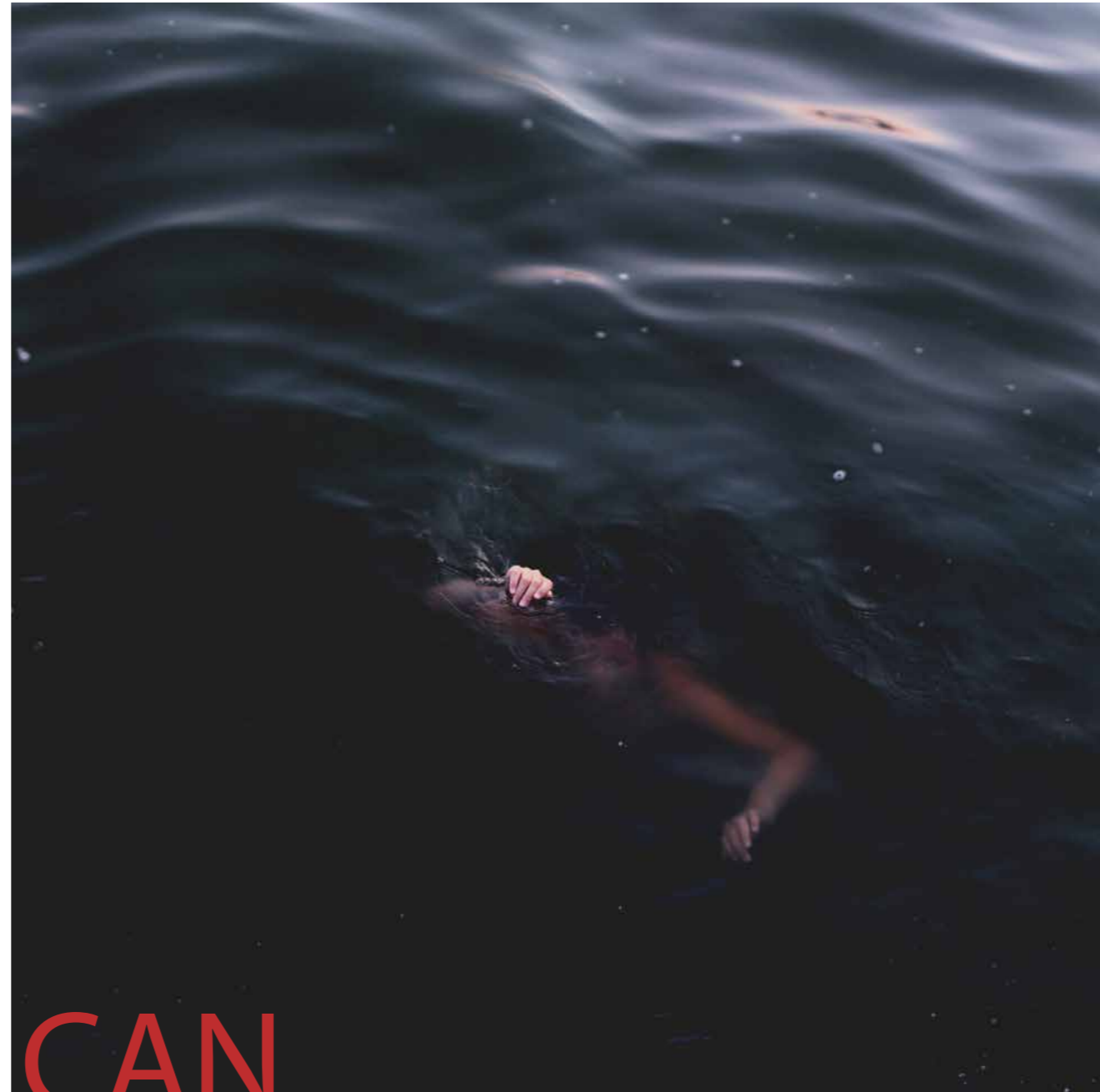

AN ADULT CAN
DROWN IN 60
SECONDS -ACTIVE TIMES

HOW CAN THE LIFEGUARDS BE MORE **RESCUE**

READY IN THE COLDER NOW MORE POPULATED MONTHS?

95% OF A LIFEGUARDS JOB
IS PREVENTATIVE



THE OTHER 5% ARE RESCUES
AND FIRST AIDS
-RNLI

ATTEMPT ONE: 01:19
ATTEMPT TWO: 01:21
ATTEMPT THREE: 01:22

AVERAGE TIME:
01:21



HOW LONG DOES IT TAKE FOR A LIFEGUARD TO GET CHANGED OUT OF THEIR CURRENT WINTER GEAR?

Q8

WHAT COLOUR DO YOU ASSOCIATE WITH A LIFEGUARD?

RED=38%

RED/YELLOW=36%

YELLOW=21%

ORANGE/RED=3%

BLUE AND RED=3%

G
U
A
R
D

SURF LIFE SAVERS AT SYDNEY BEACH, 1941



ROCHESTER, NYC, AUGUST 3, 1935



SHADOW LAKE, FRANKLIN LAKES, NJ, 1934





REPURPOSE



REPAIR AND MAINTENANCE



REMOVAL of IDENTIFIABLE FEATURES.



DEBRANDING



HELLY HANSEN COAT HOOD ANALYSIS

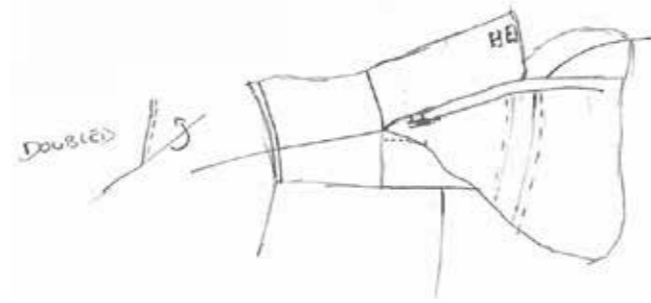
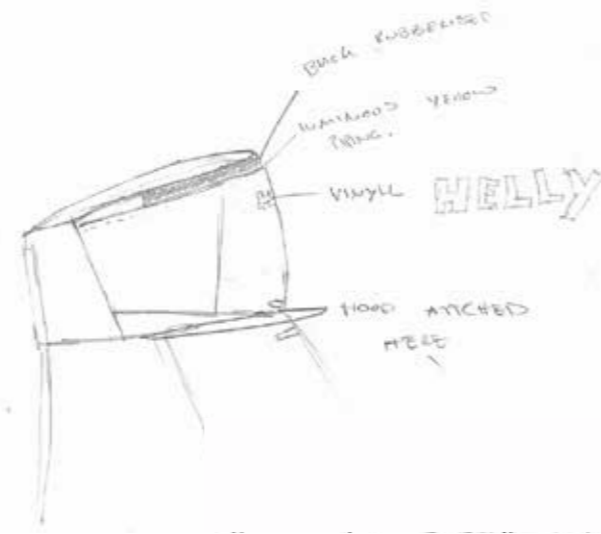

COAT

HH HOOD

SIDE

PIPING DETAIL

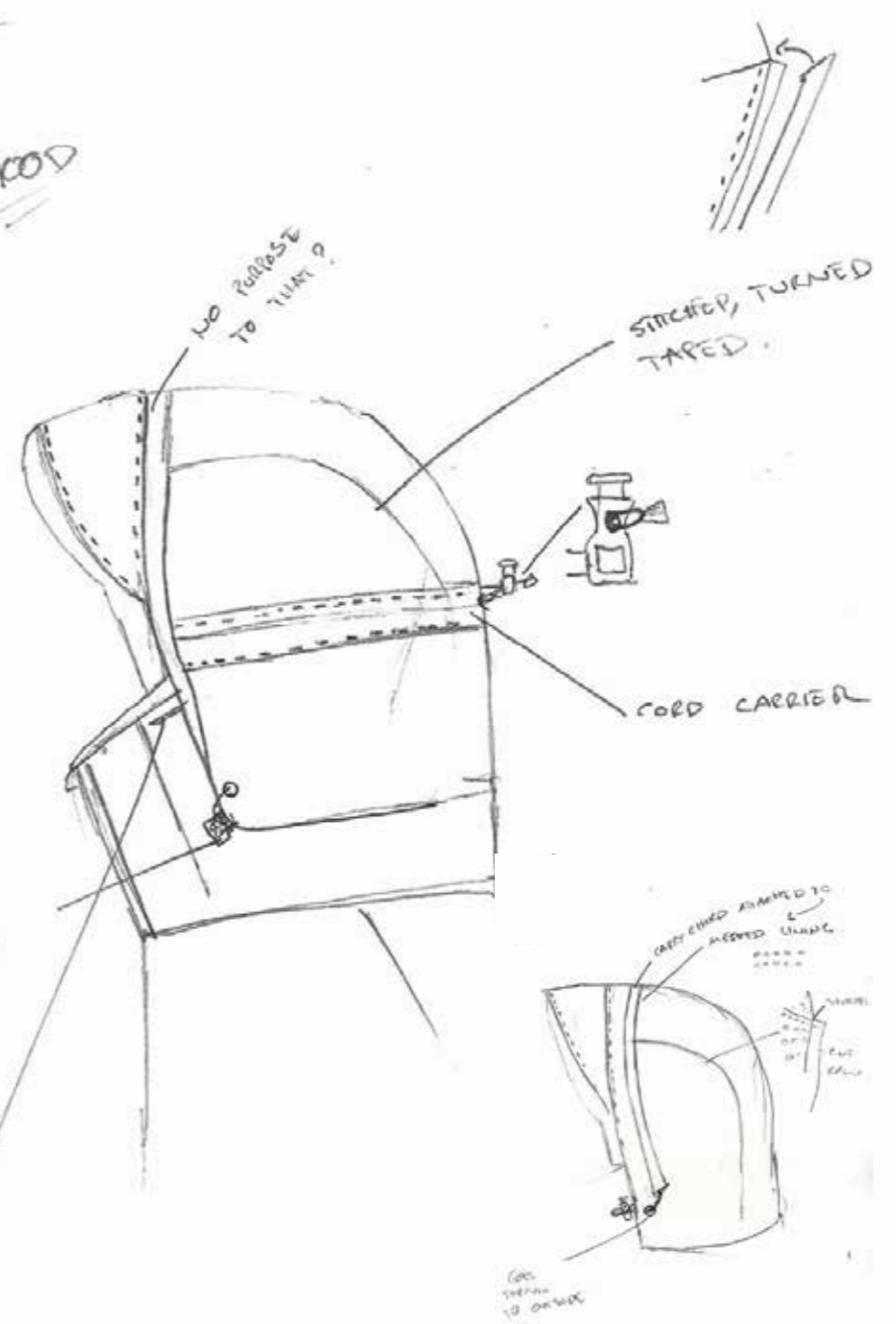

TOILE NO.3, NO.4, ELASTICATED ZIP ENTRY

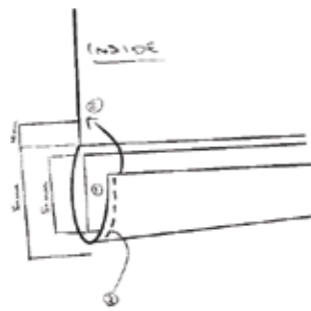
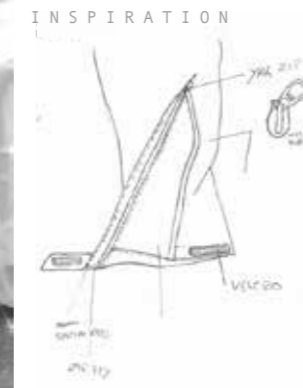

- ① PLACE 5mm ELASTIC 60mm UP FROM HEM
- ② ENSURE EDGE IS TURNED 60mm
- ③ EDGE STRETCH ELASTIC & OUTER BODY FABRIC TO SECURE ZIP LENGTH.

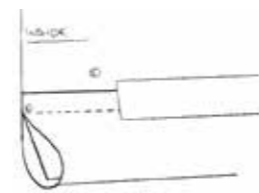

- ④ 1cm EDGE STITCH
- ⑤ ZIP TAPE



- ⑥ STITCH ZIP IN - EDGE STITCH - THIS LAYER ATTACH
- ⑦ THE EXTERIOR SIDE OF ZIP TO SEAL



LONGER ZIP NEEDED FOR MORE EASE

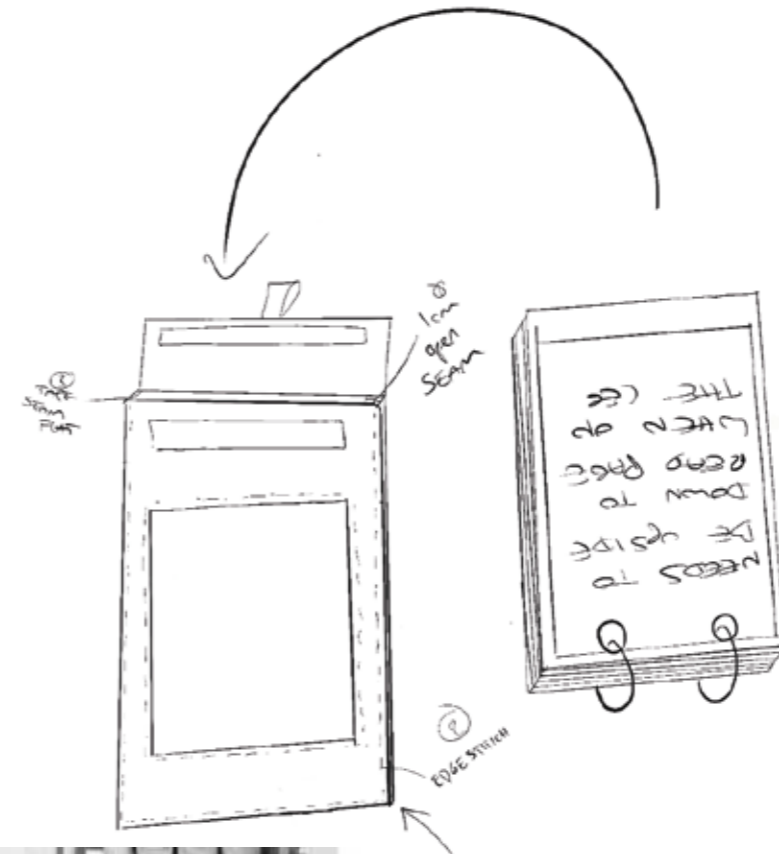
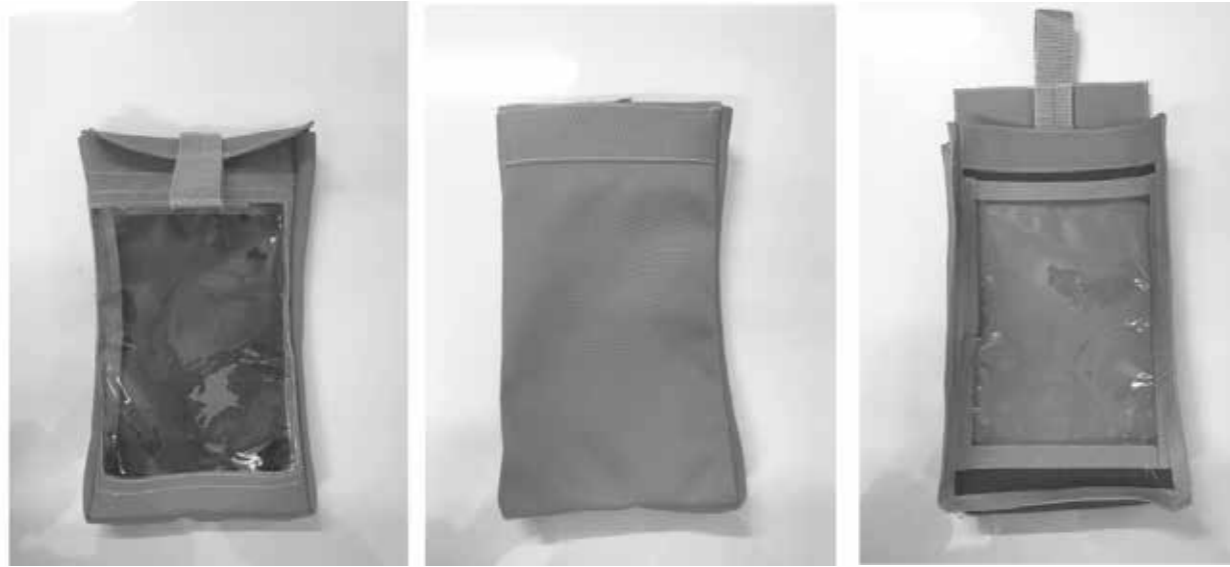

POCKET NO.2
REMOVAL OF GUSSET MADE
IT TOO TIGHT

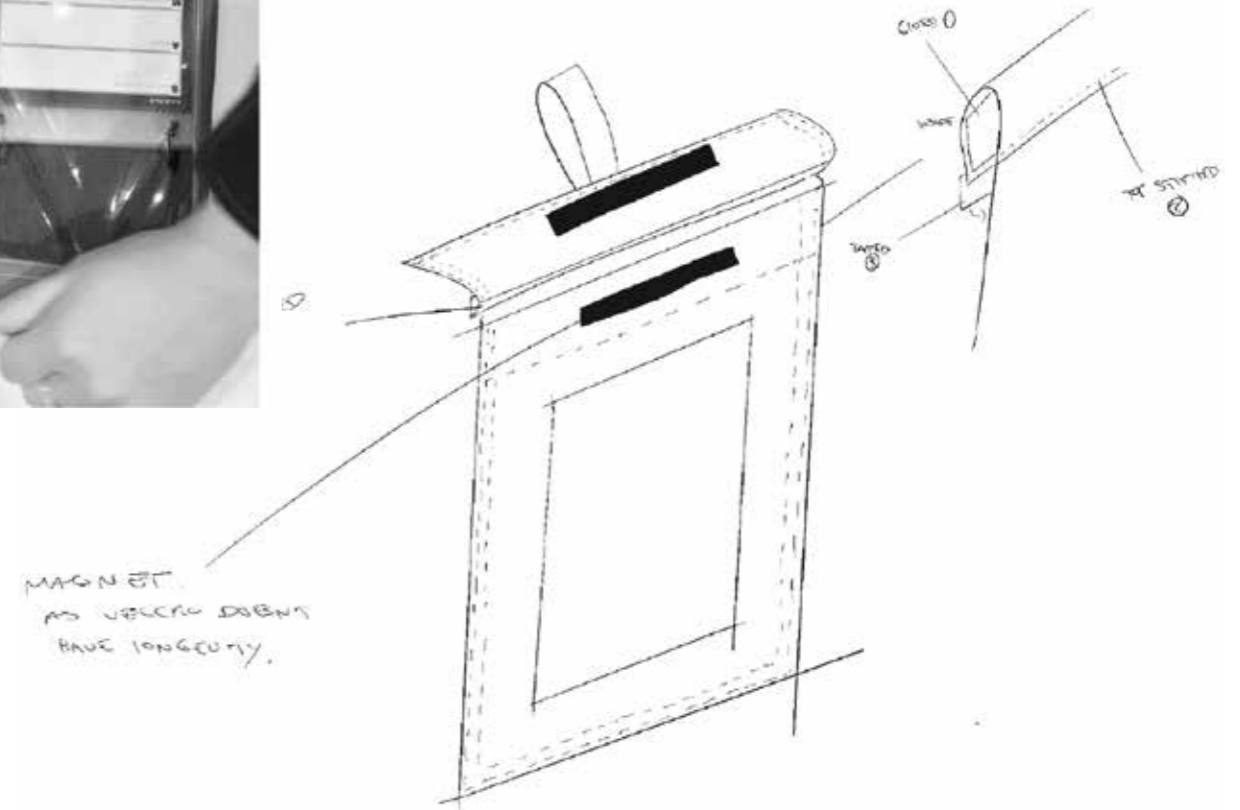

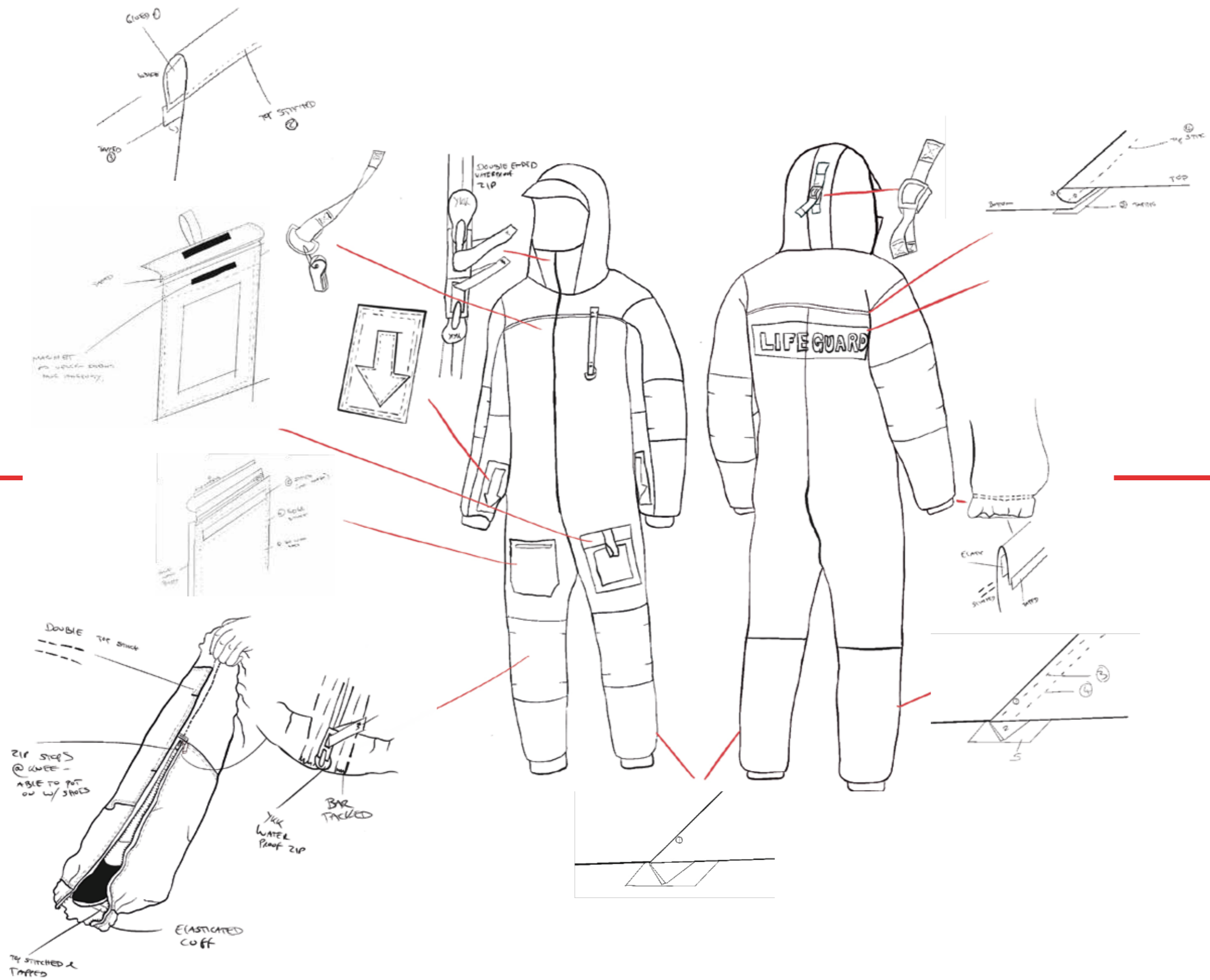



PHOTOGRAPHS BY ROSS PARKER



PHOTOGRAPHS BY ROSS PARKER



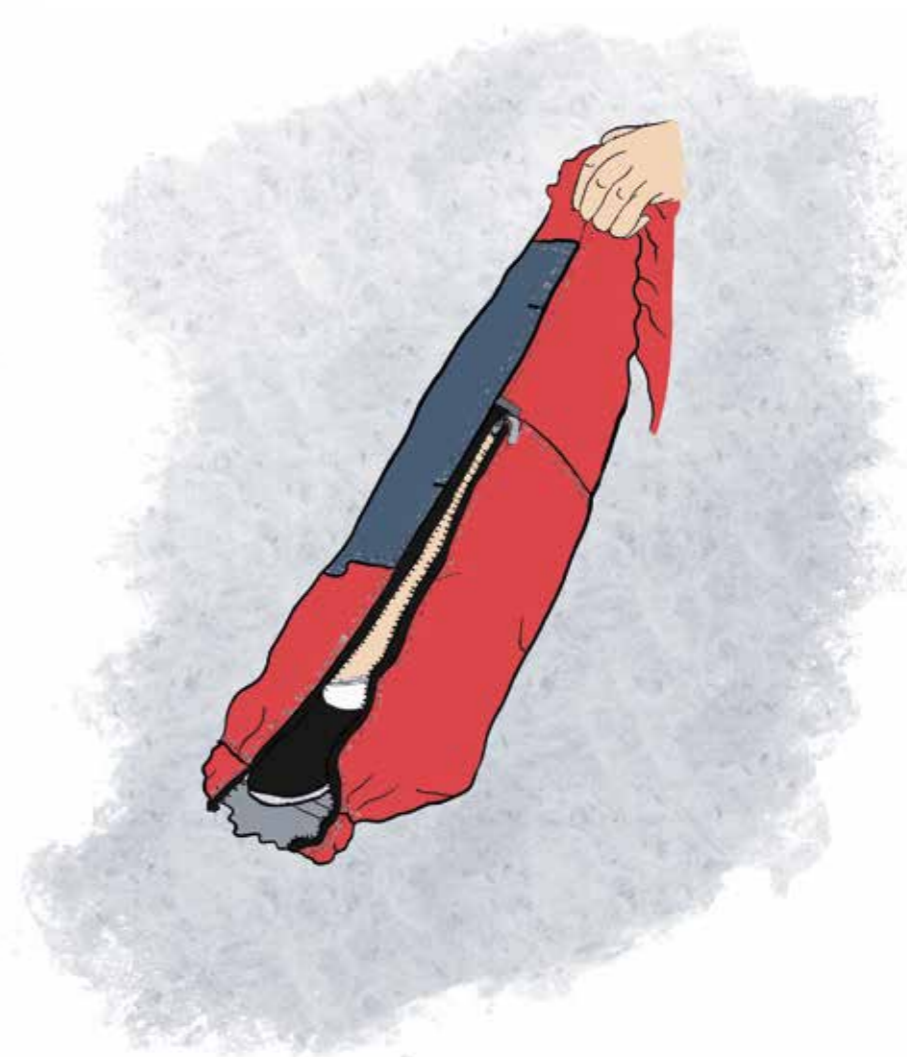

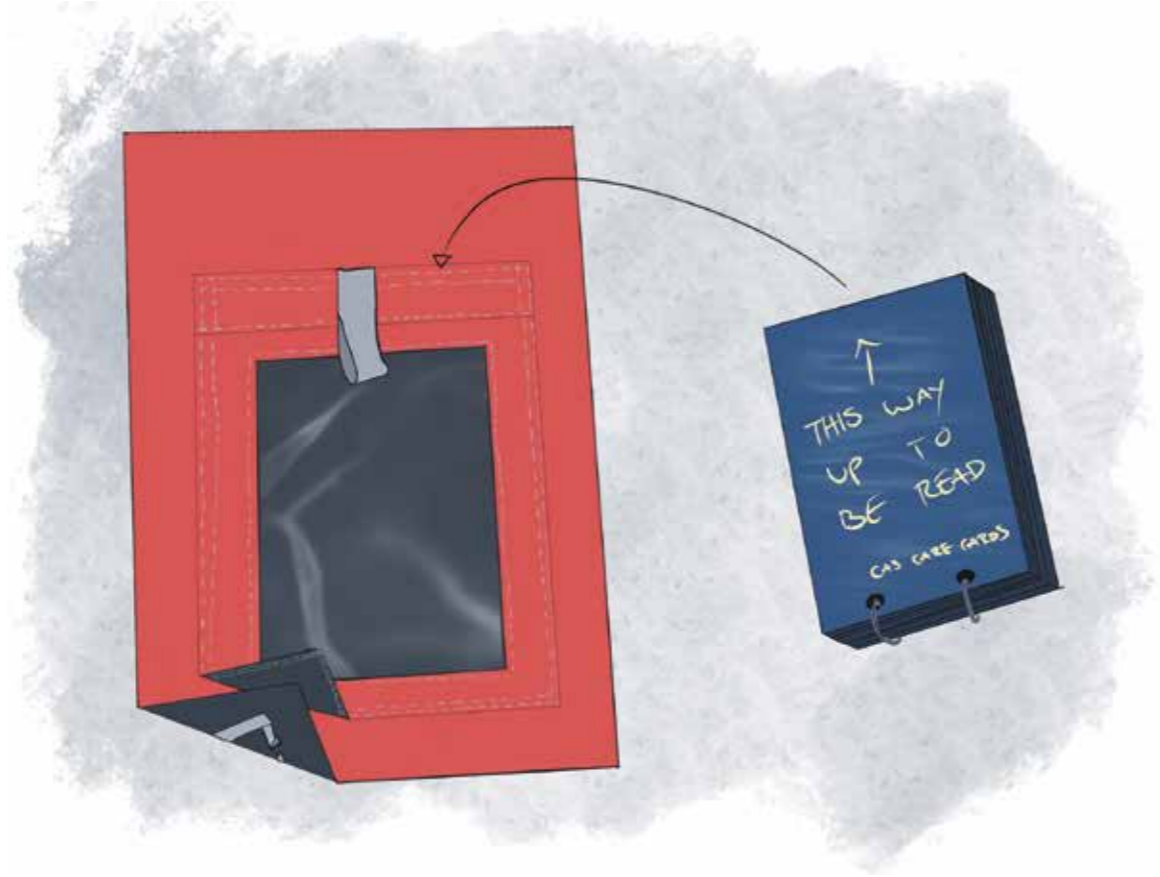

EXAMPLES OF BEACH ACCESS

TOLCARNE



LUSTY GLAZE



FISTRAL

EXAMPLES OF BEACH ACSESS TO THE BEACH LIFEGUARD UNIT (BLU). HARD WHEN CARRYING THE KIT BOX.

T H E
B O X



STRAIN ON THE BACK



AWKWARD TO CARRY.



HARD TO GRIP

STRAIN ON THE ARMS

CANNOT MOVE EASILY

NOT ENOUGH ROOM FOR WETSUIT / NO PLACE FOR LEFT WETSUIT.



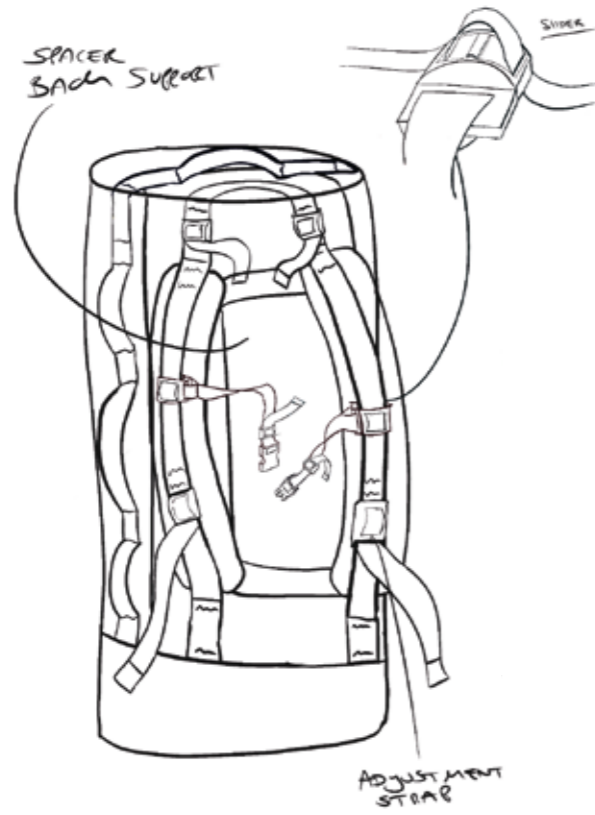

PAPER TOILE NO.1

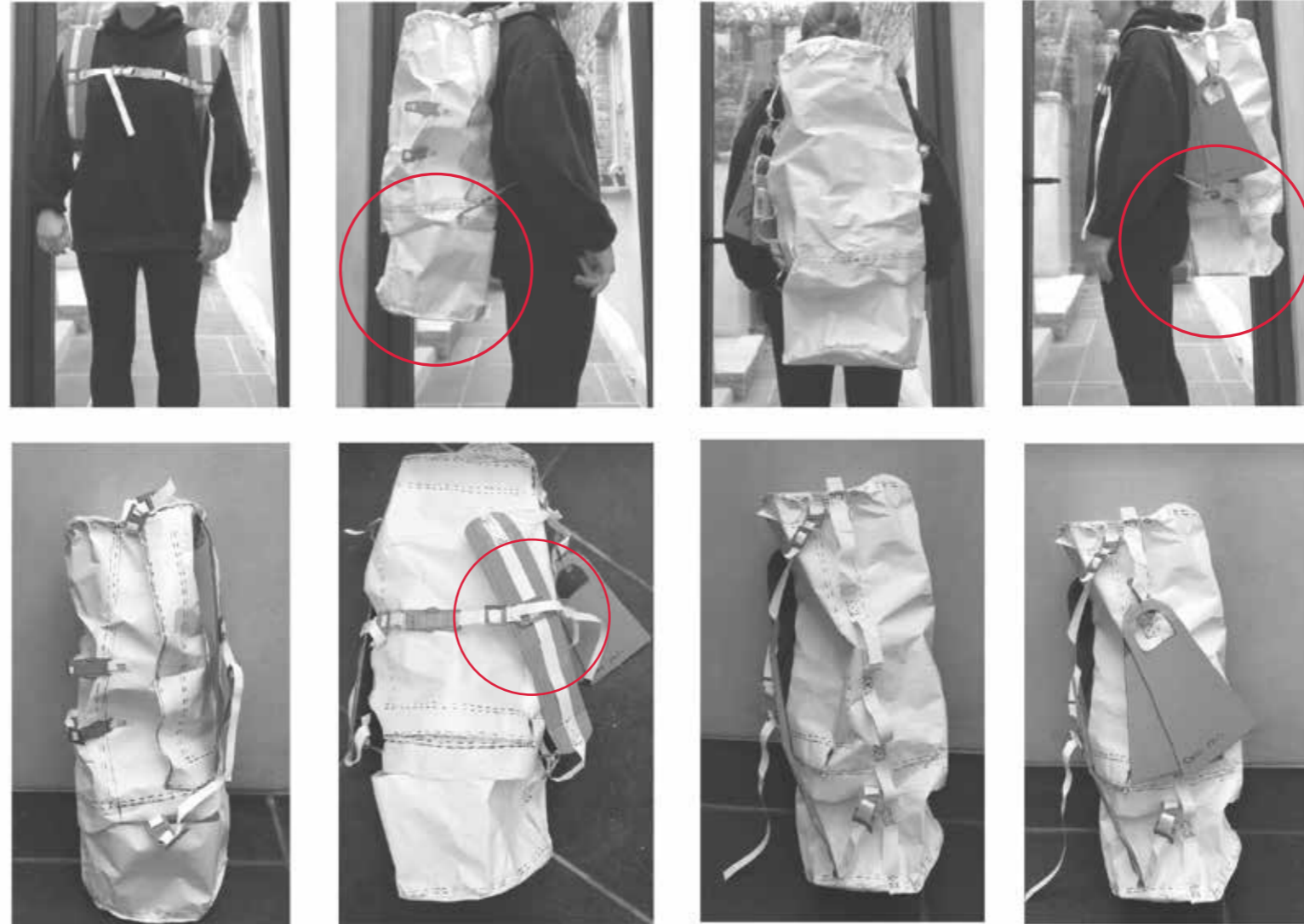

SITS TOO LOW ON BACK (TOO LONG)
STRAPS TOO LARGE

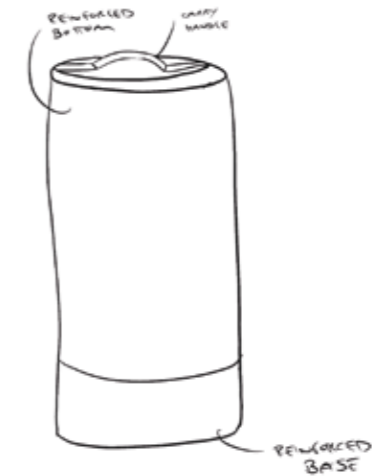
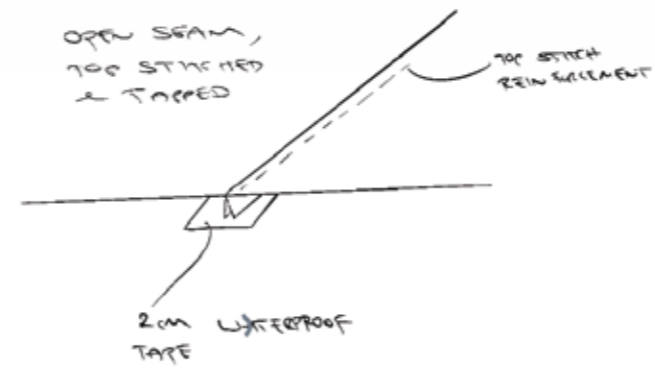

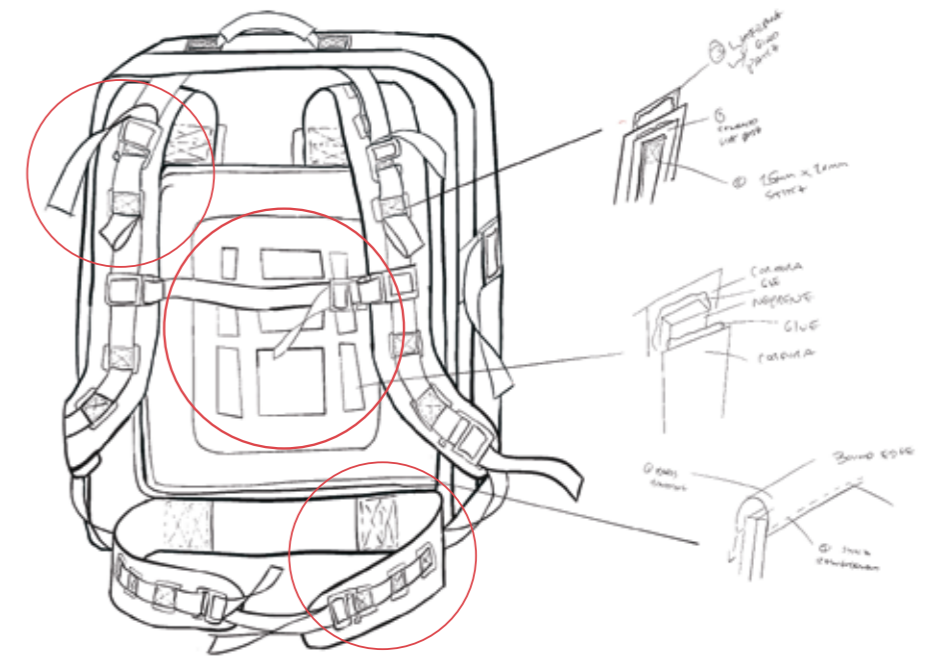

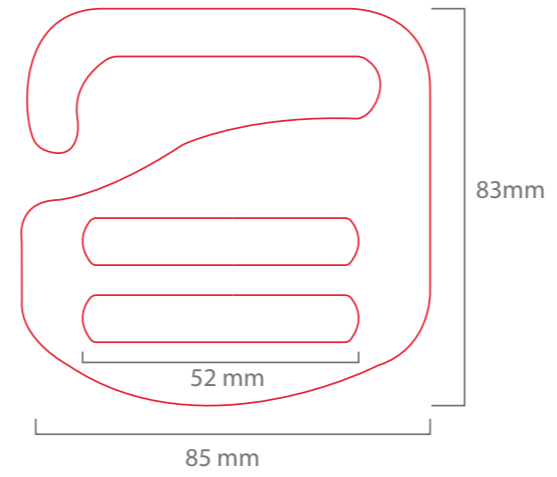
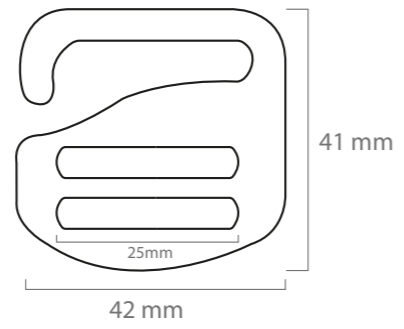

CONTACT LEFT G-HOOK



SAMPLE LASER CUT 3MM PLY 50MM G-HOOK



50MM SPRAYED CUT STEEL G-HOOK

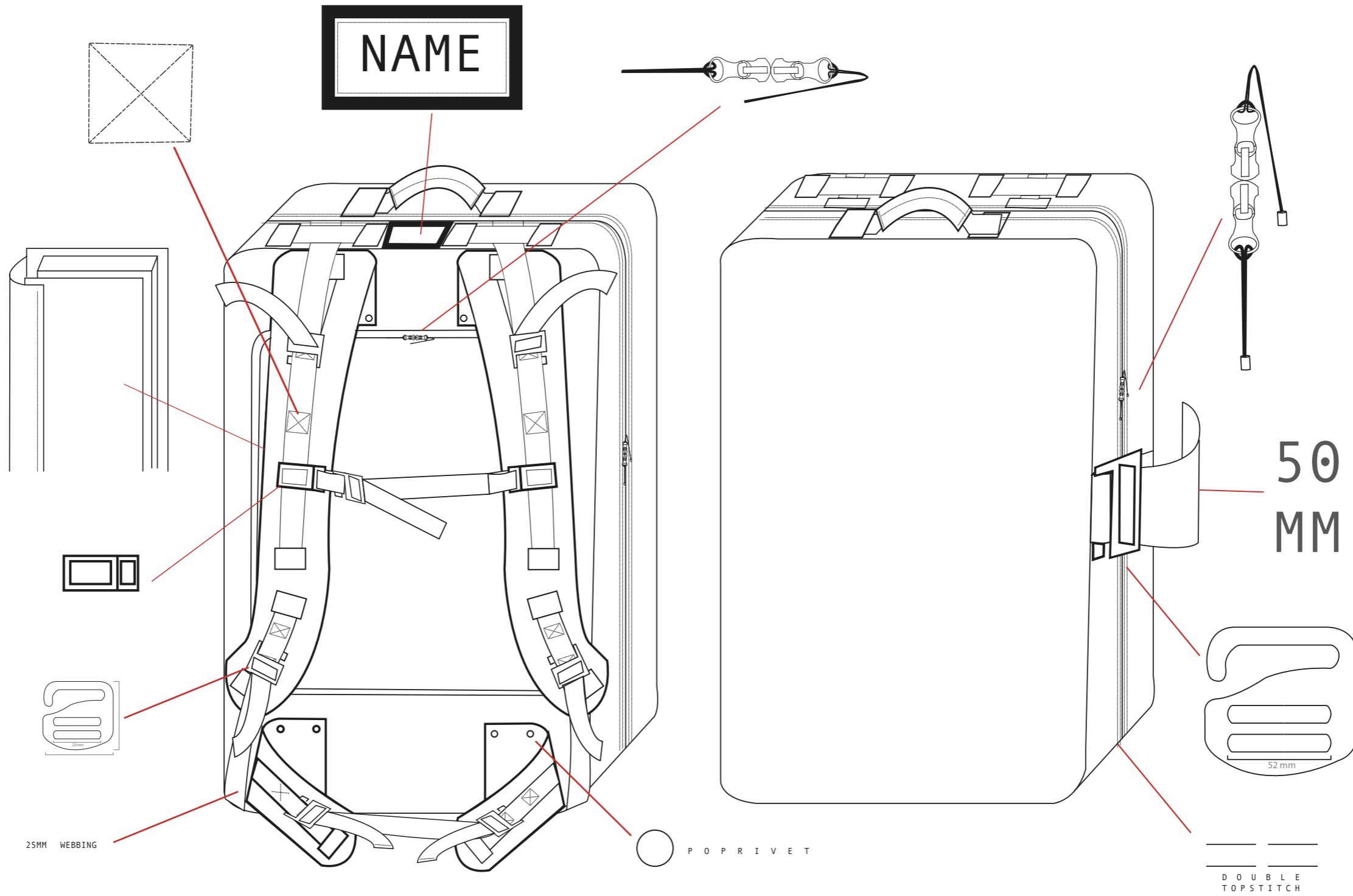



PHOTOGRAPHS BY ROSS PARKER



PHOTOGRAPHS BY ROSS PARKER





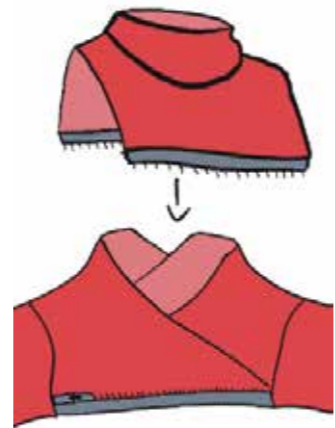

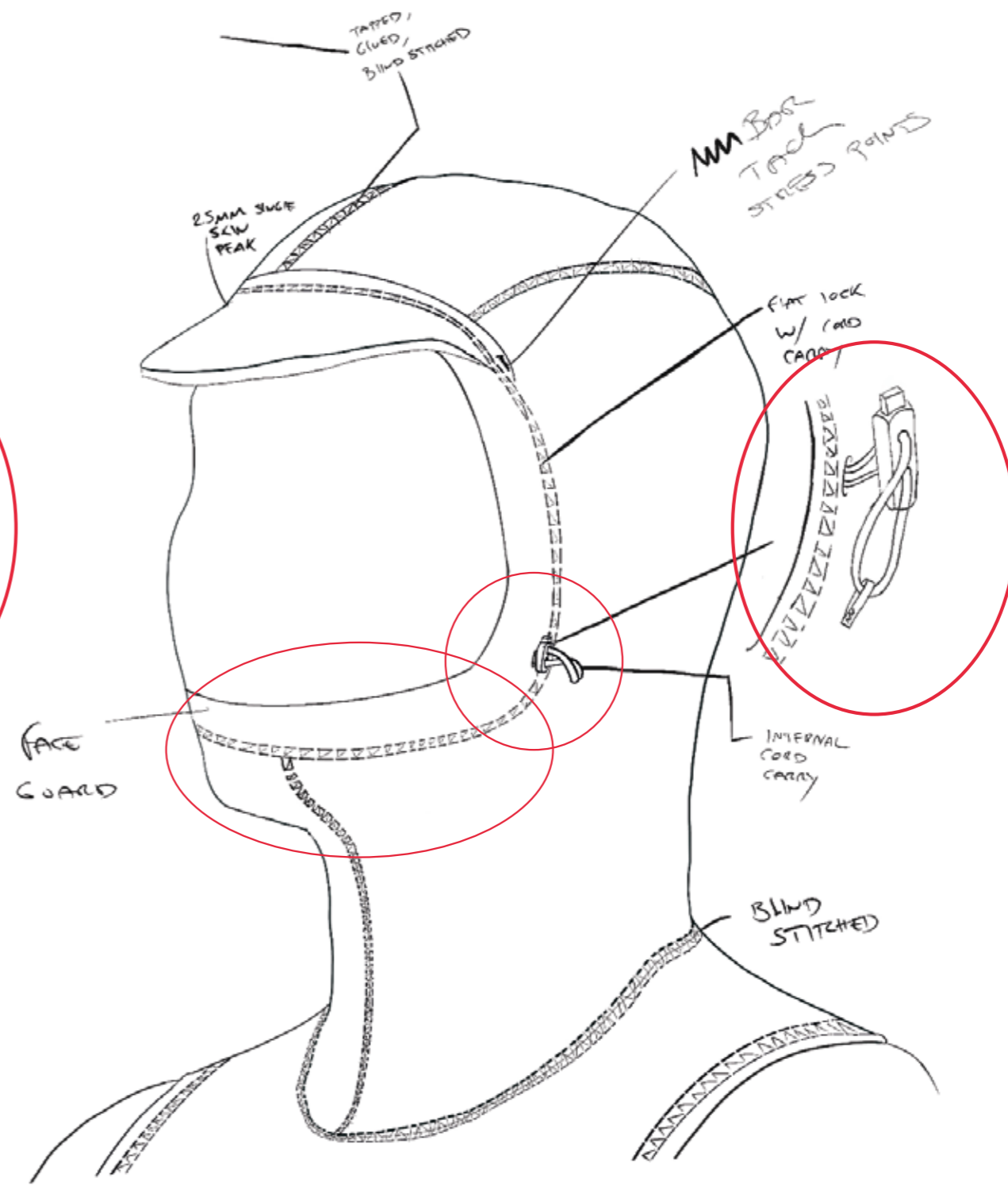
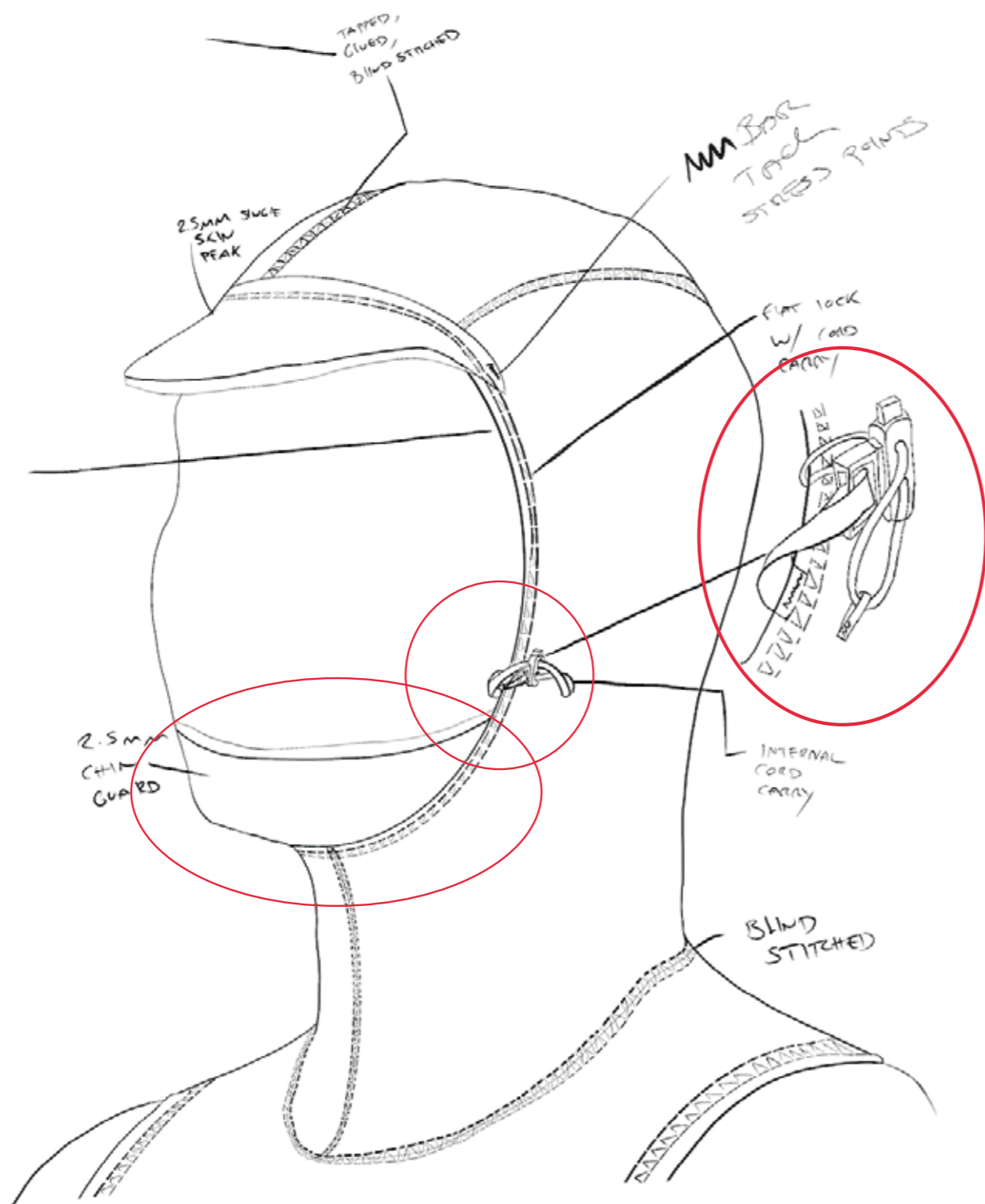

ADDITIONAL ALTERATIONS FOR FINAL MAKE

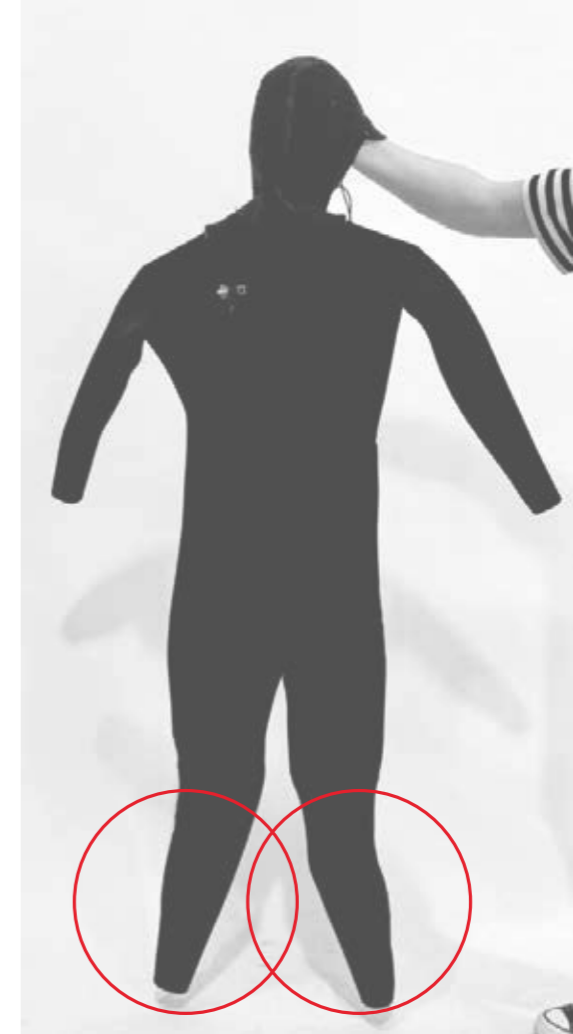

L I F E G U A R D

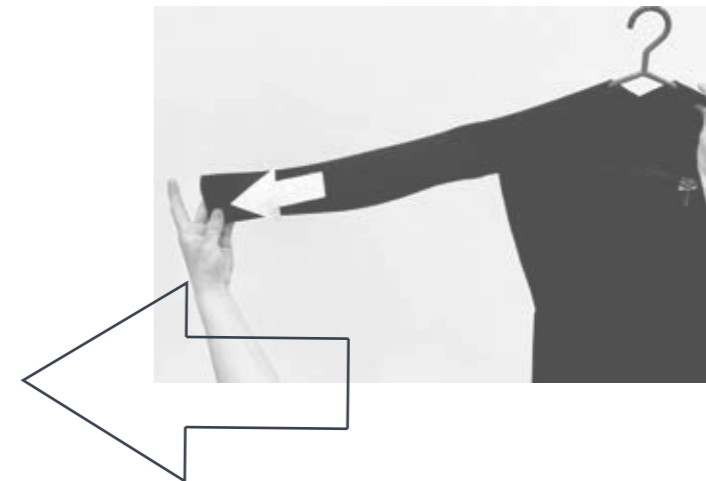

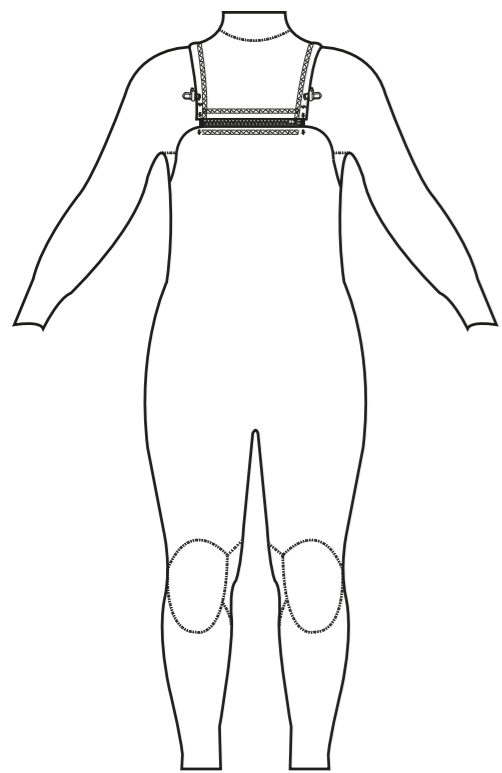

FRONT

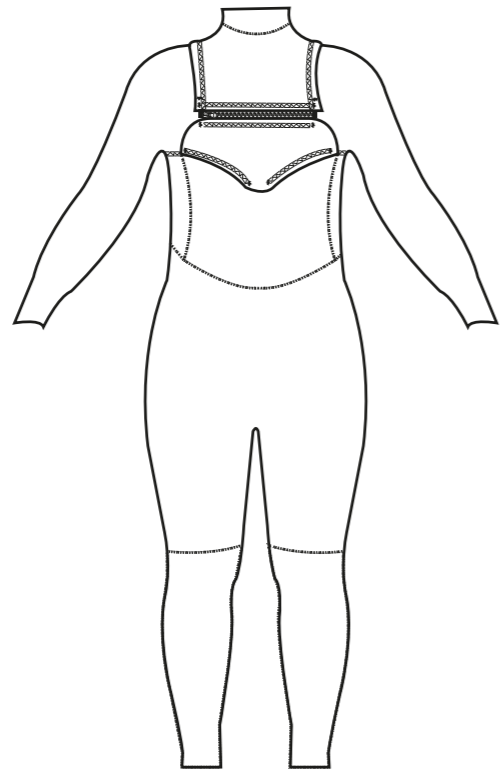

BACK

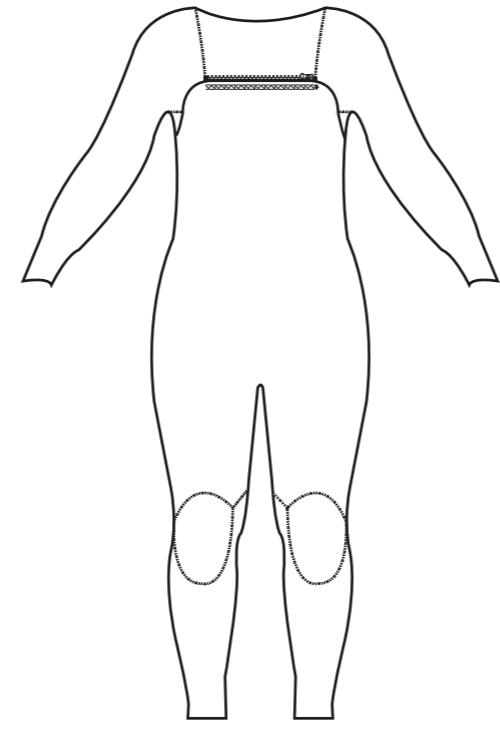

FRONT

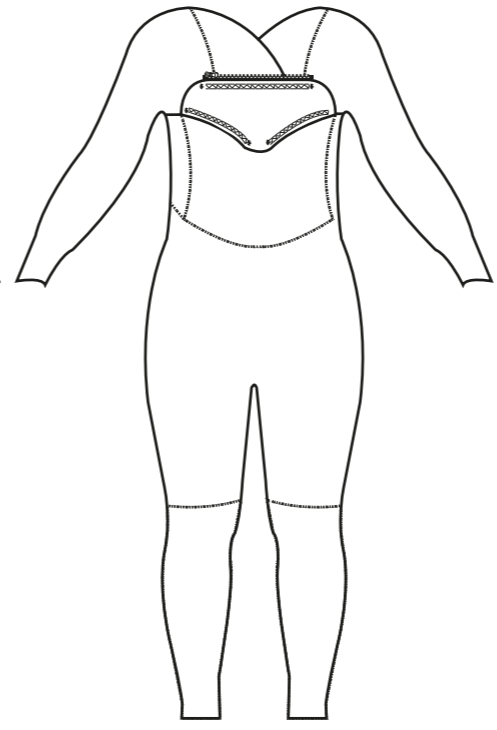

BACK

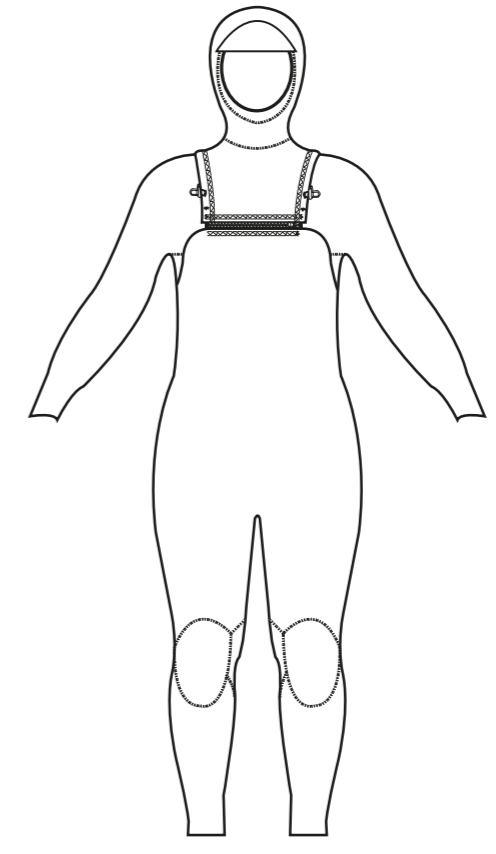

FRONT

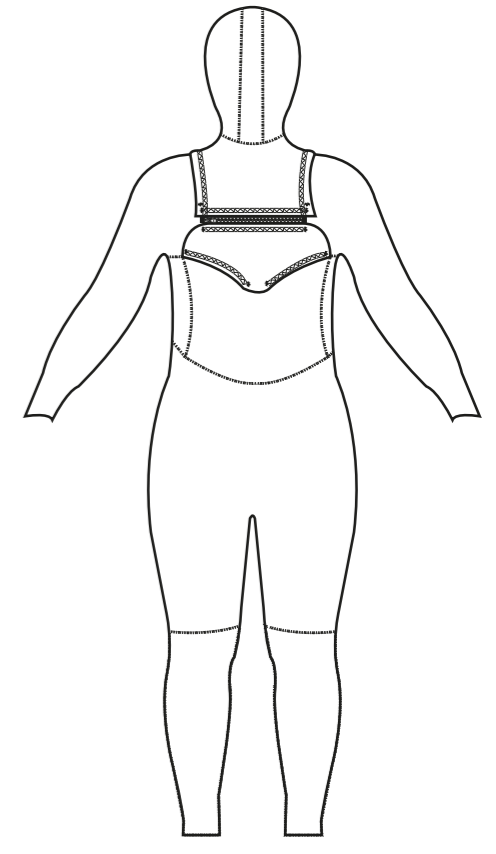

BACK

SPRING/AUTUMN NECK

WINTER NECK

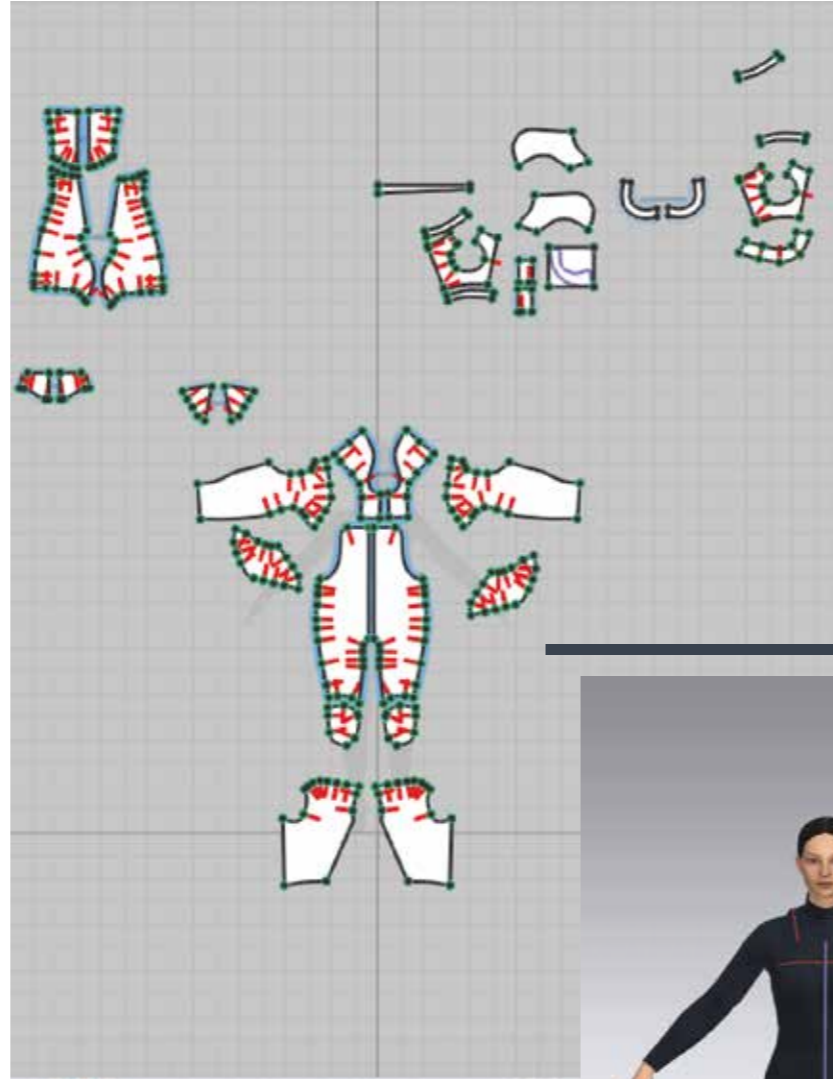
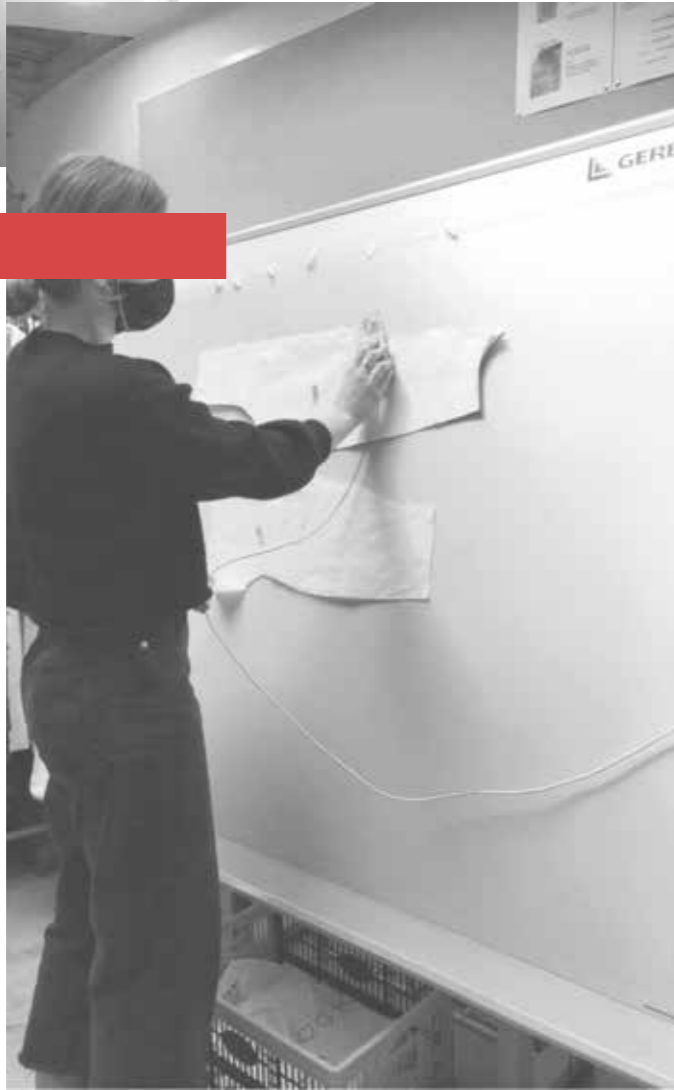
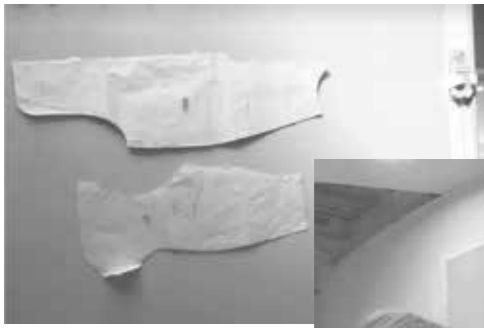

DIGITALISE PATTERN



SUCCESSFUL ALTERATION

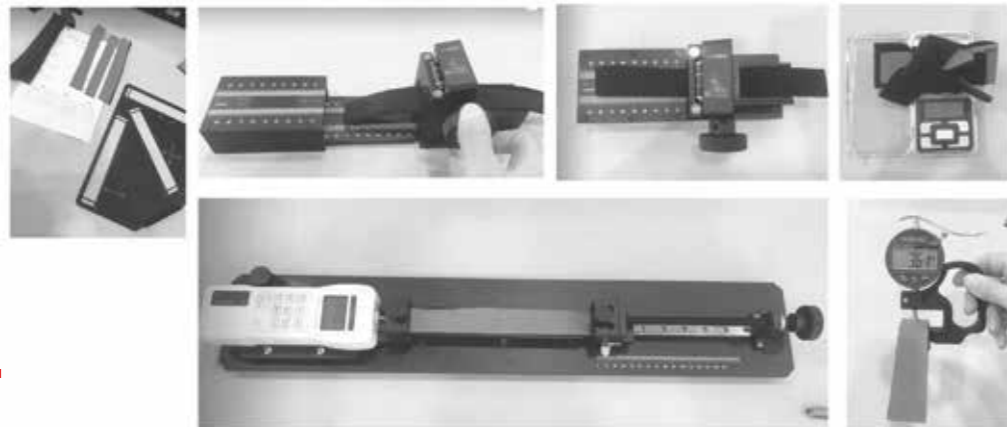



SPRING/AUTUMN NECK



WINTER NECK



FINISHINGS



