

ECHOES OF A LIFE

AMELIA DYER

+447850672950
ameliapdyer@gmail.com

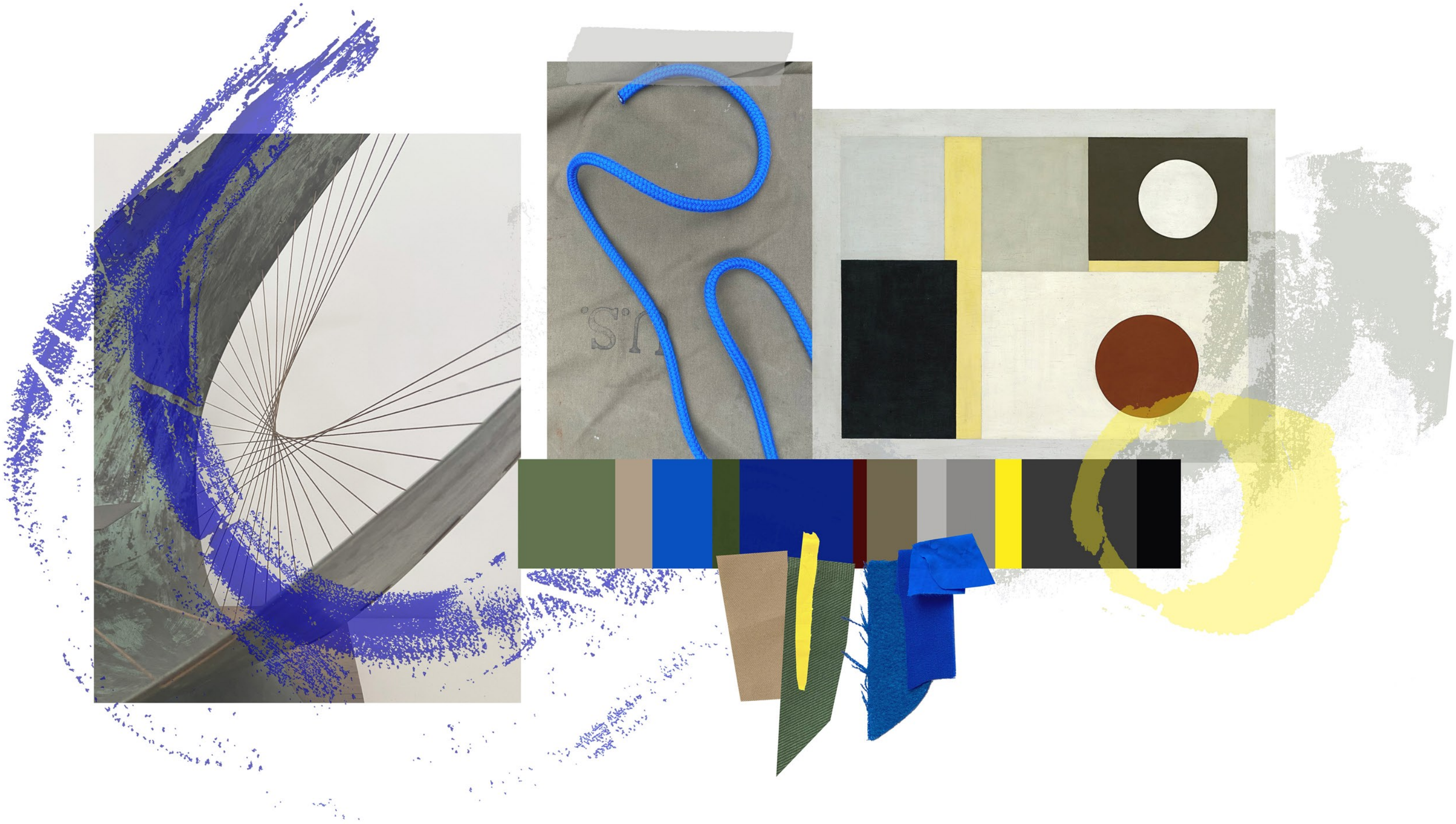

ECHOES OF A LIFE
AMELIA DYER

+447850672950
ameliapdyer@gmail.com



ECHOES OF A LIFE
AMELIA DYER

+447850672950
ameliapdyer@gmail.com

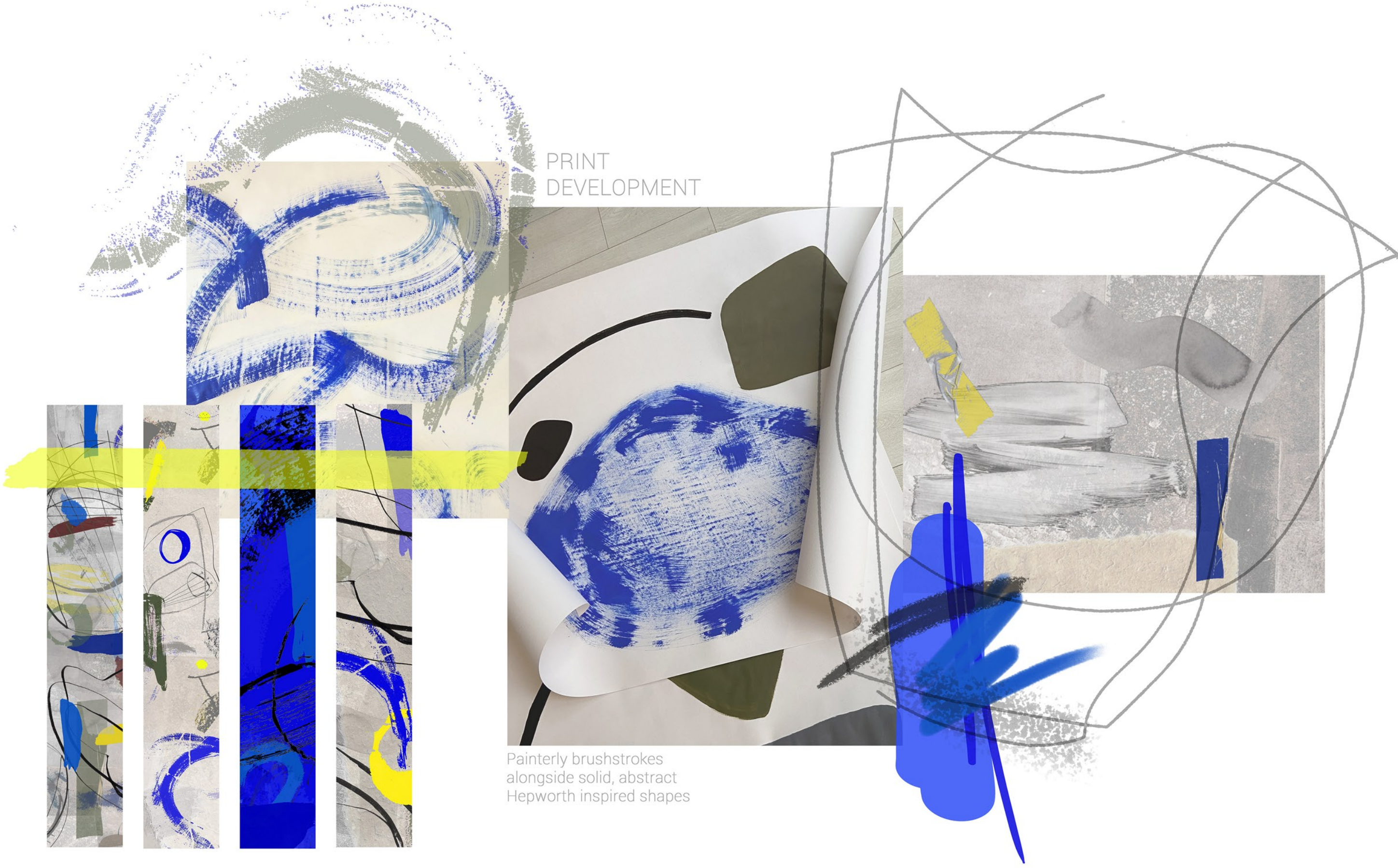

PRINT
DEVELOPMENT

Painterly brushstrokes
alongside solid, abstract
Hepworth inspired shapes

ECHOES OF A LIFE

AMELIA DYER

+447850672950
ameliapdyer@gmail.com

LOOK 1
KNIT DEVELOPMENT

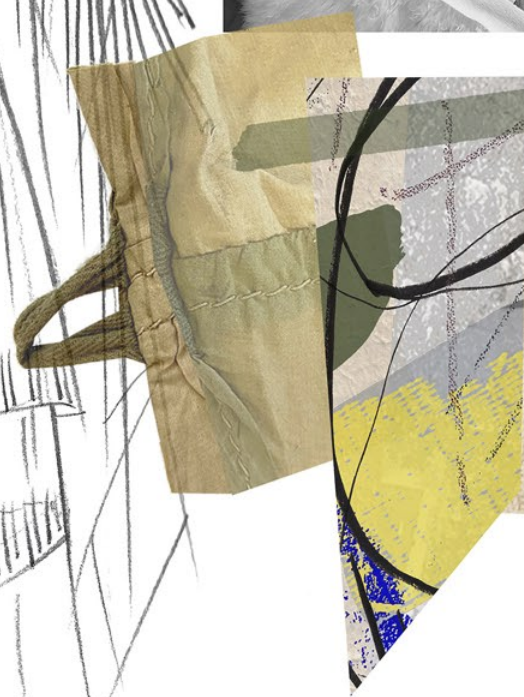

Sculptural rib knit,
mixed with utility
upcycled tent skirt

ECHOES OF A LIFE
AMELIA DYER

+447850672950
ameliapdyer@gmail.com

LOOK 2
DEVELOPMENT



Printed, manipulated
ties, against structured,
crisp pleating

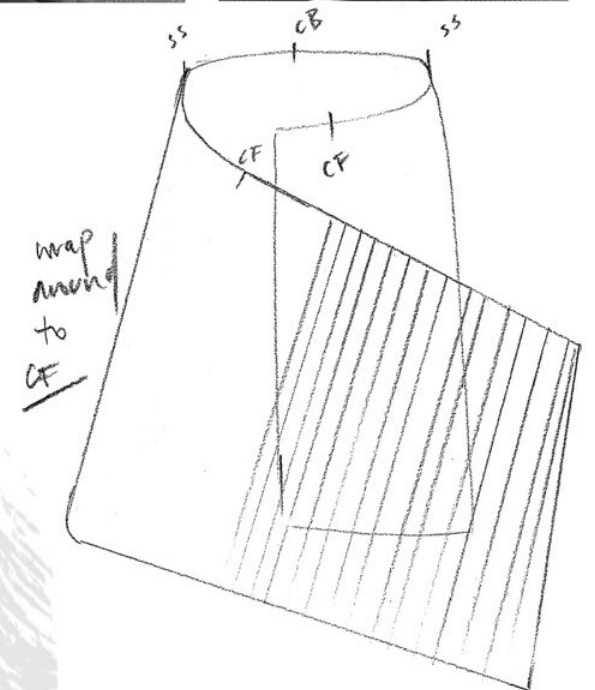
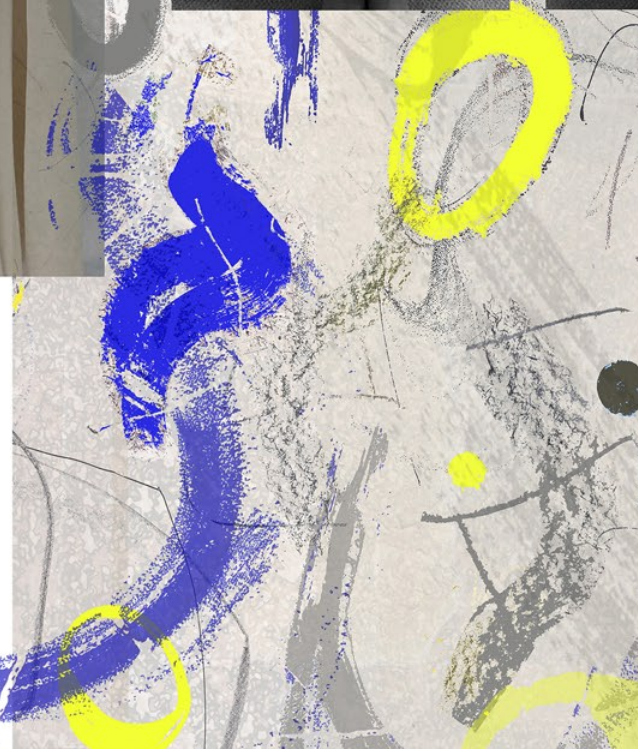
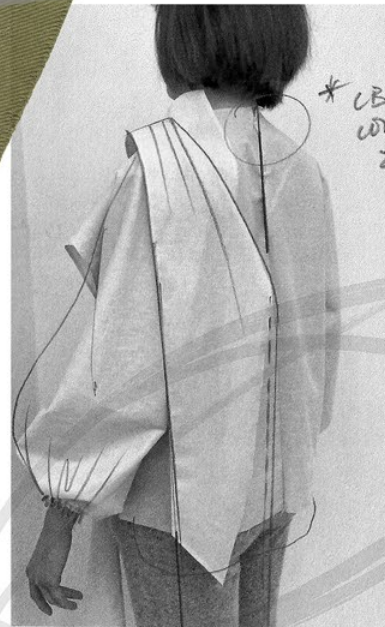

ECHOES OF A LIFE
AMELIA DYER

KNOT DETAIL BLOUSE LOOK 2

DIGITAL PRINT ARTWORK

100% ORGANIC COTTON POPLIN
135 GSM

ARTWORK TO SCALE, REFERRING TO
MEASUREMENTS BELOW

ALL MEASUREMENTS IN CM



ECHOES OF A LIFE
AMELIA DYER

PLEAT WRAP SKIRT LOOK 2

100% COTTON KHAKI
Twill
ALL MEASUREMENTS
IN CM

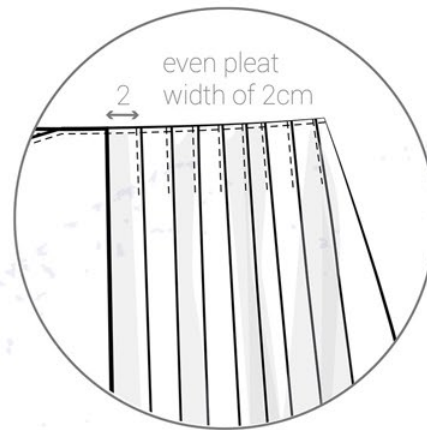

each pleat edgestitched
4.5cm from top of waist

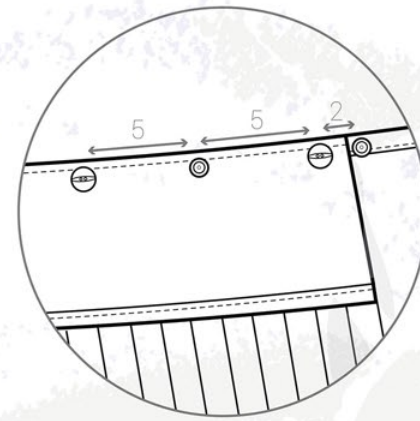

internal fastenings include
x2 clear plastic buttons &
x2 brass poppers

FRONT VIEWS

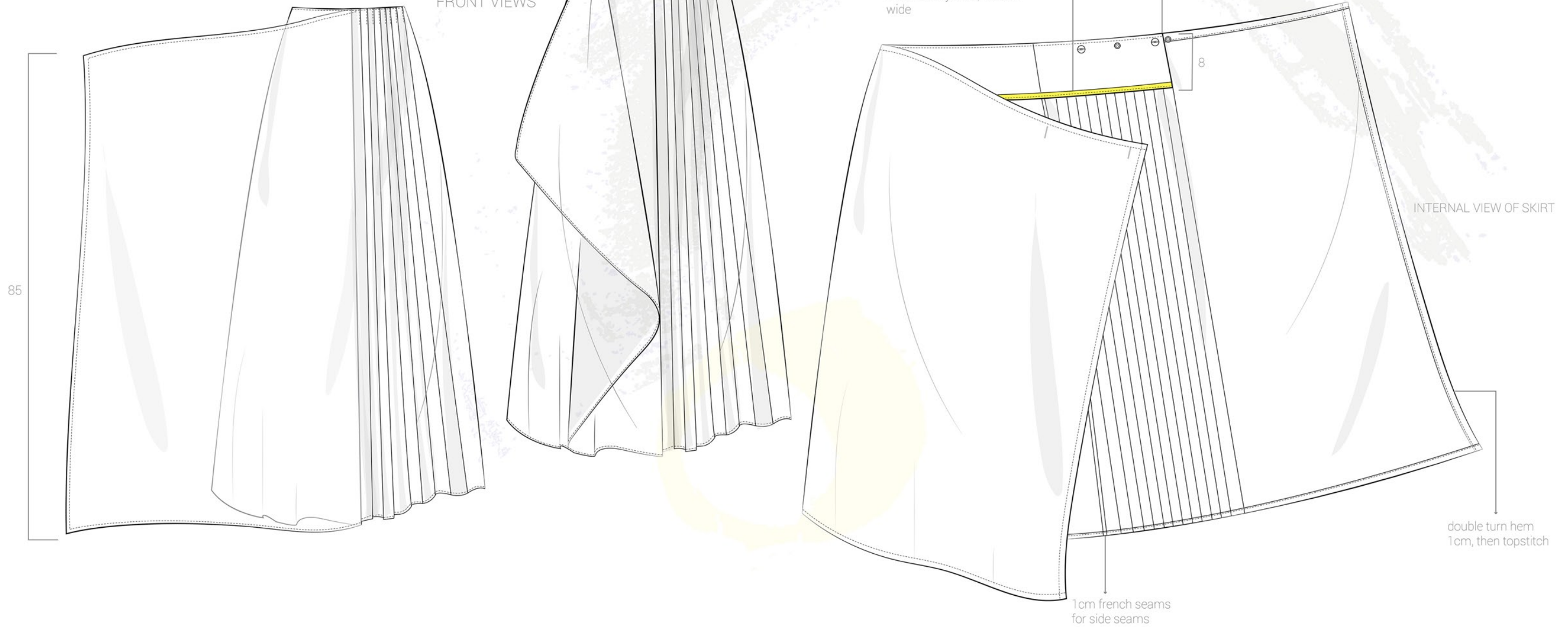

ECHOES OF A LIFE
AMELIA DYER

LOOK 3
KNIT DEVELOPMENT

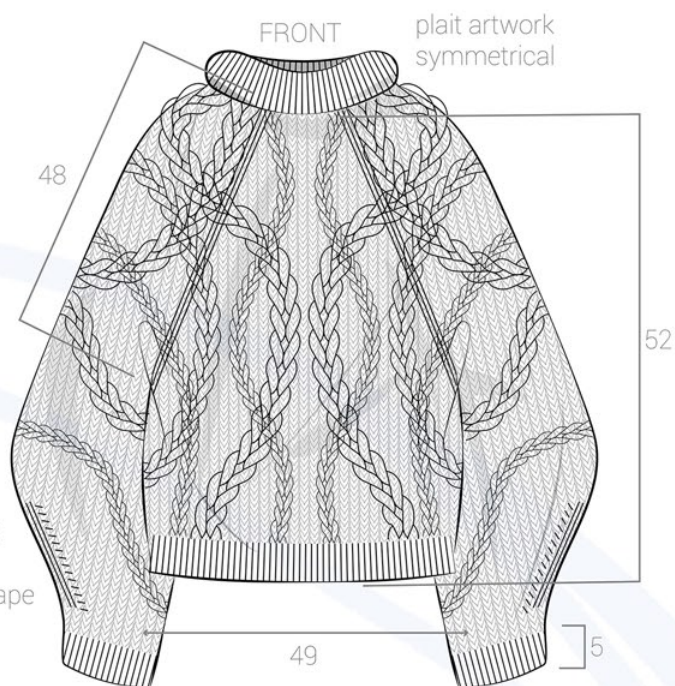

Couched on plaits,
echoing the movement
of my print artwork

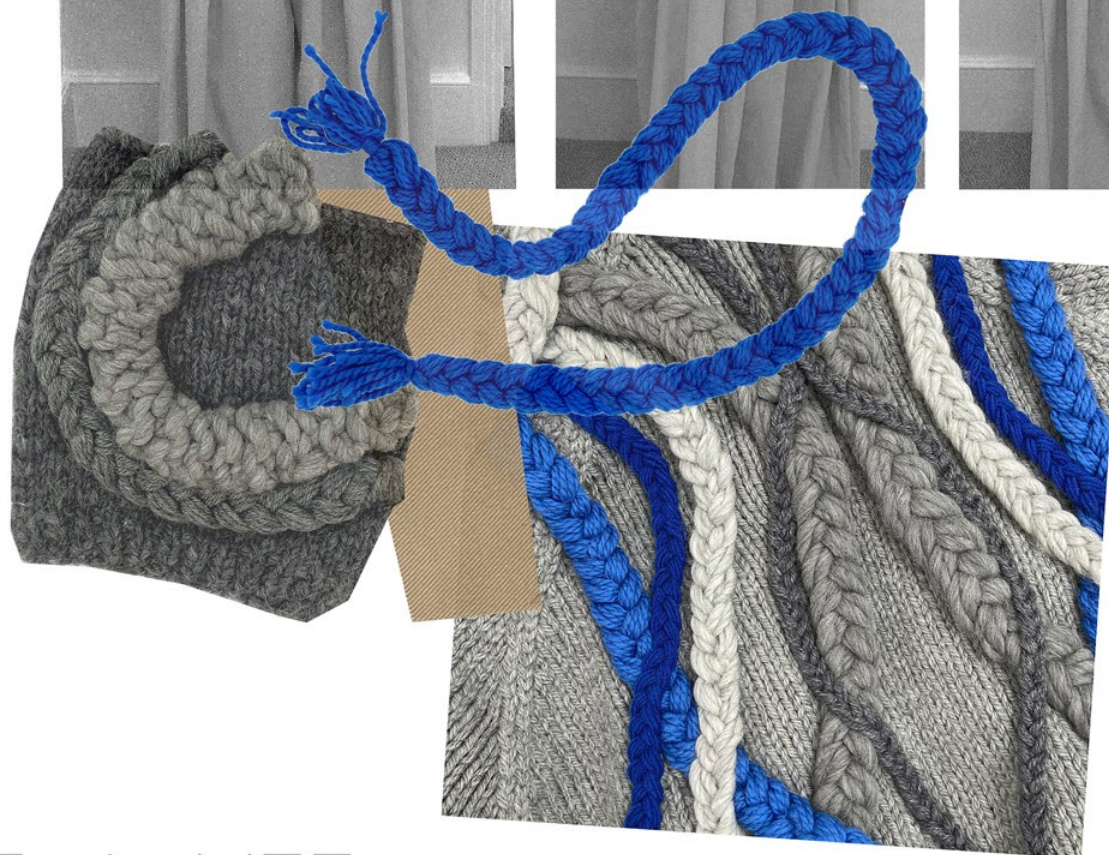
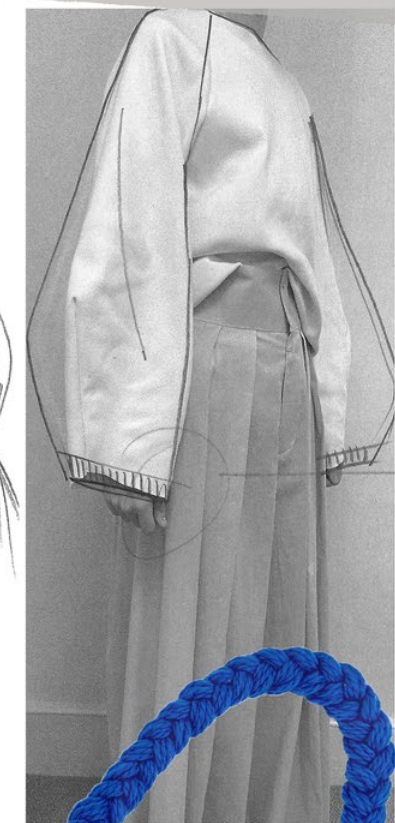
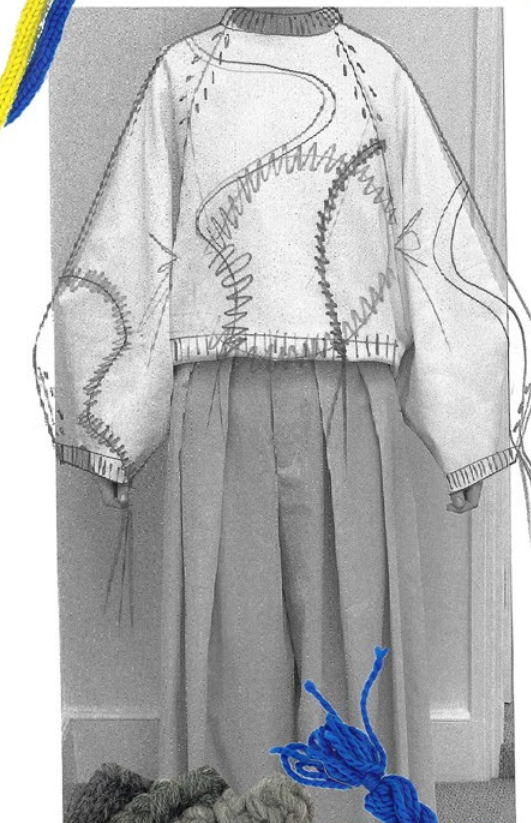

ECHOES OF A LIFE
AMELIA DYER

LOOK 4
DEVELOPMENT



ECHOES OF A LIFE
AMELIA DYER

+447850672950
ameliapdyer@gmail.com

PRINTED GATHER DRESS
LOOK 4

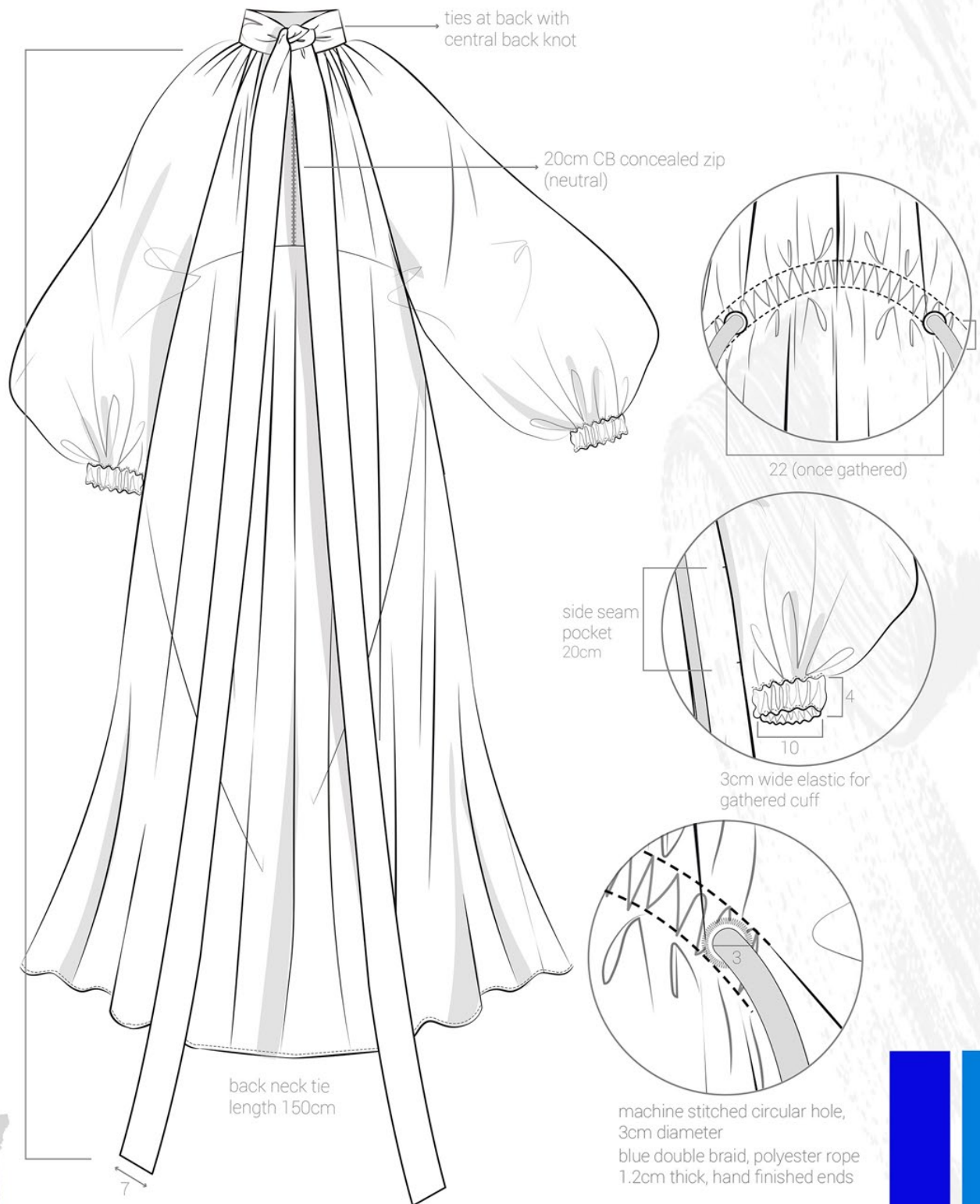
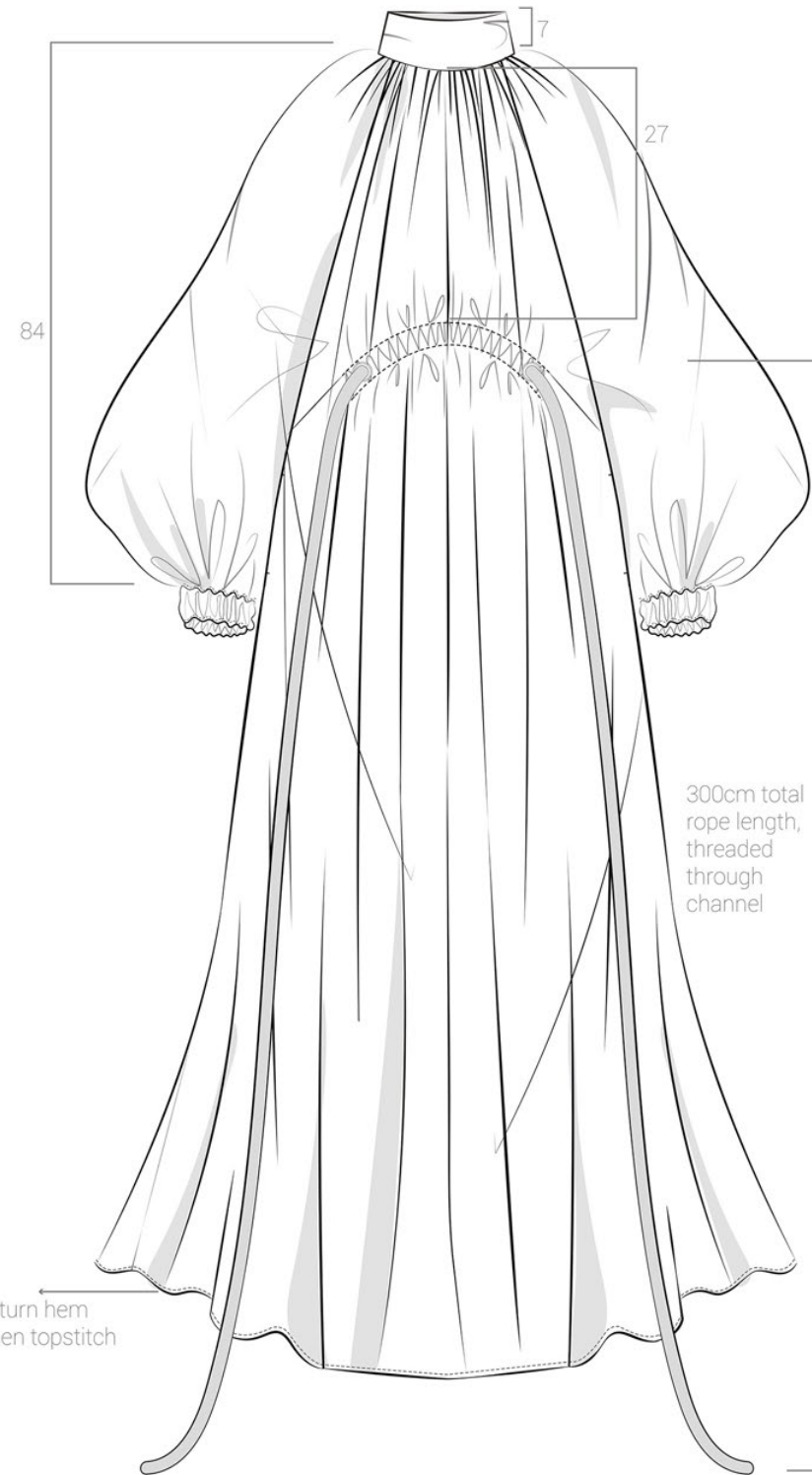

DIGITAL PRINT ARTWORK

100% ORGANIC COTTON POPLIN
135 GSM

ALL OVER PRINT DRESS

ARTWORK TO SCALE, REFERRING TO MEASUREMENTS BELOW

ALL MEASUREMENTS IN CM



ECHOES OF A LIFE
AMELIA DYER

LOOK 5 DEVELOPMENT

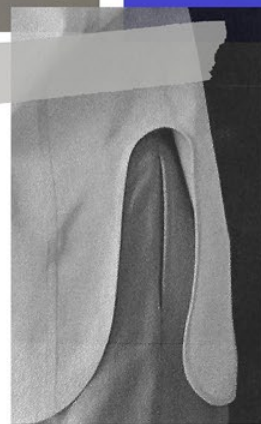

Cocoon silhouettes,
alongside fluid printed
shirting



LOOK 6 TABARD
DEVELOPMENT

↑ cropped length
high/low



statement
deep
facings
on sleeve

* long ties
inserted



extreme
2x2 Rib
trim

Rib 1x1
edge
+ Deep
Rib
trim



Needle felting
print shapes on
knit tabard



ECHOES OF A LIFE
AMELIA DYER



ACCESSORY DEVELOPMENT



Up-cycled bags, using 1945 original canvas war tent, combined with boat ropes and metal hardware

ECHOES OF A LIFE
AMELIA DYER



ECHOES OF A LIFE
AMELIA DYER

+447850672950
ameliapdyer@gmail.com