

PARACHUTES HAVE A 25 YEAR USAGE PERIOD.
FREEFALL EXPLORES HOW THESE TECHNICAL FABRICS
CAN BE REUSED.

Freefall.

AMY HARRINGTON

amyrharrington143@gmail.com
+44 7582084762



Kingston
University
London

Kingston
School
of Art







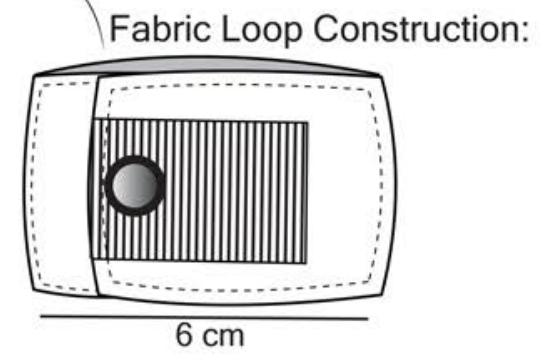
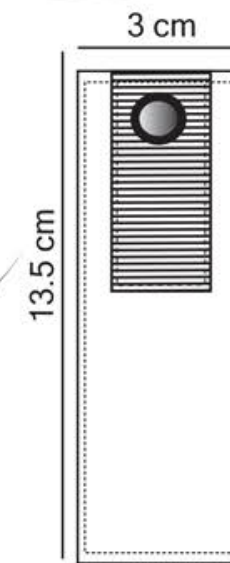
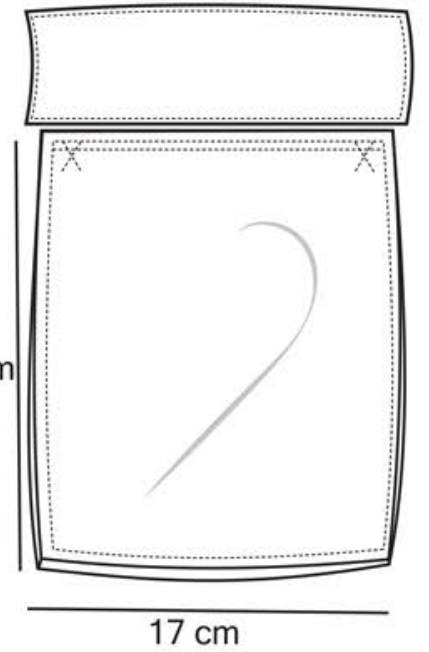
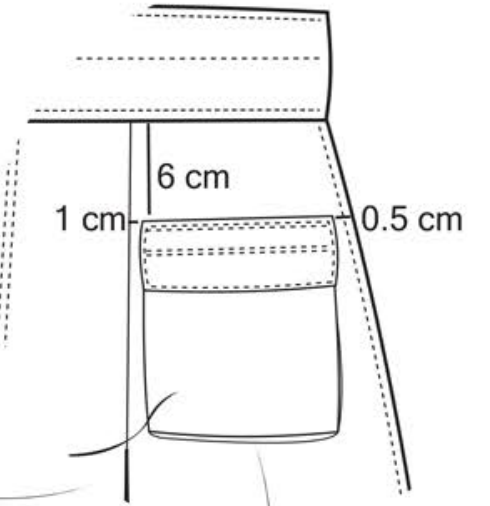
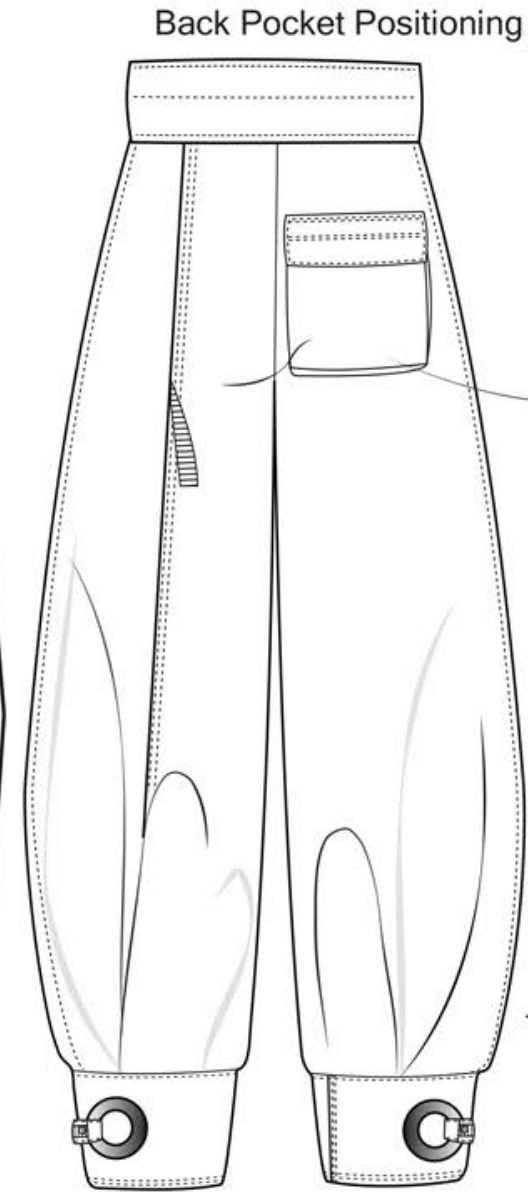
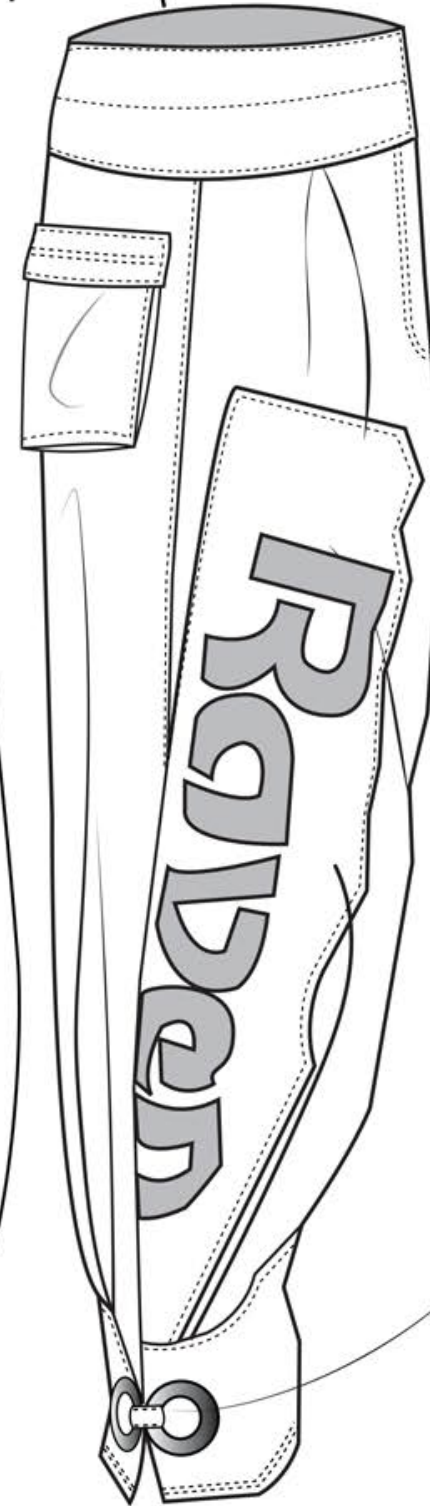
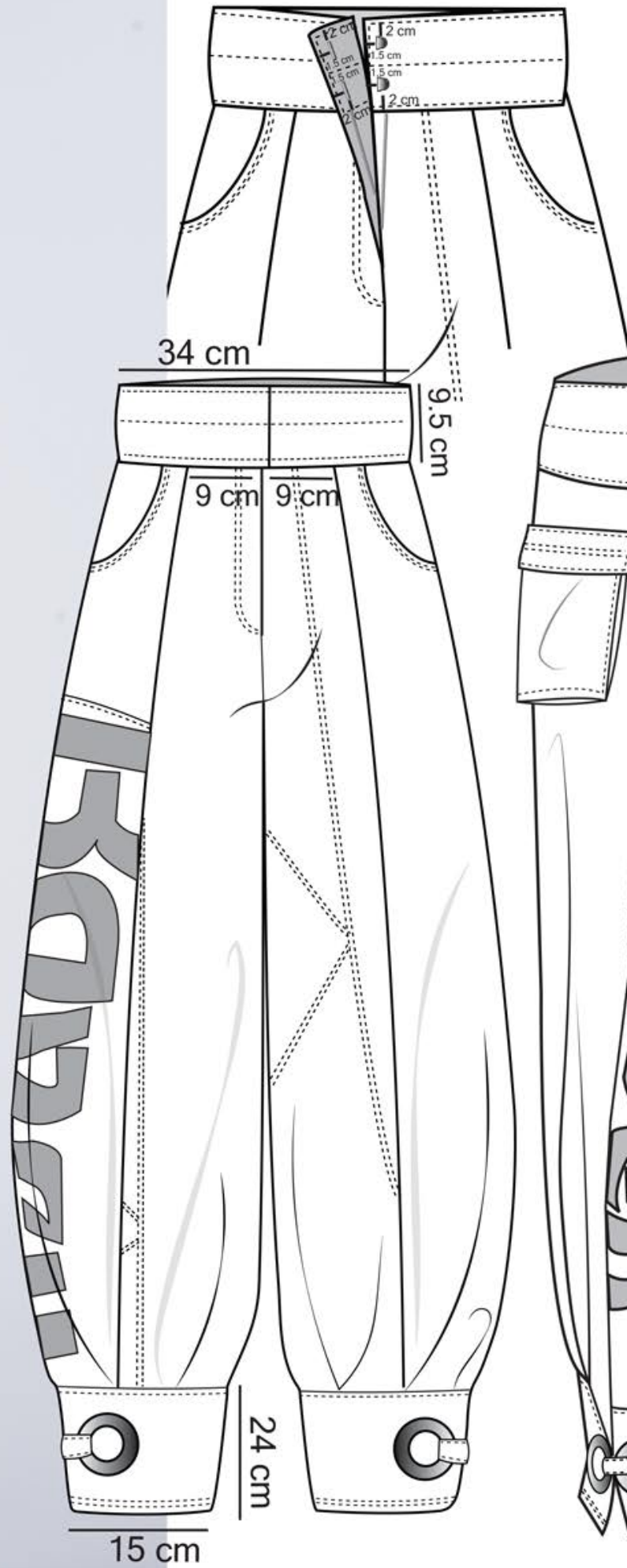



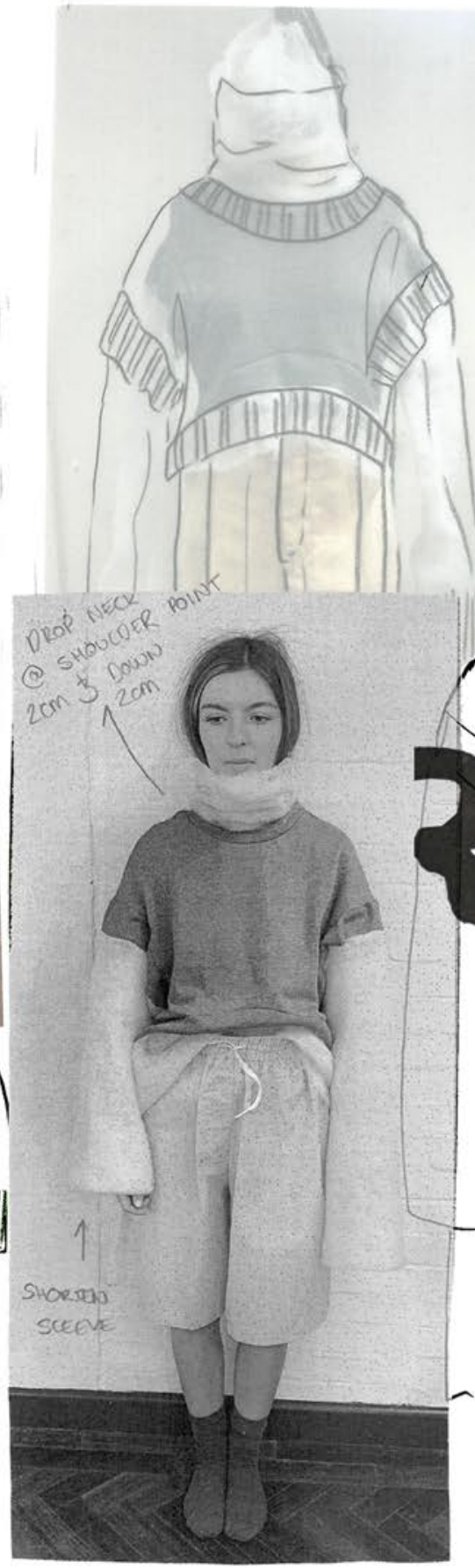
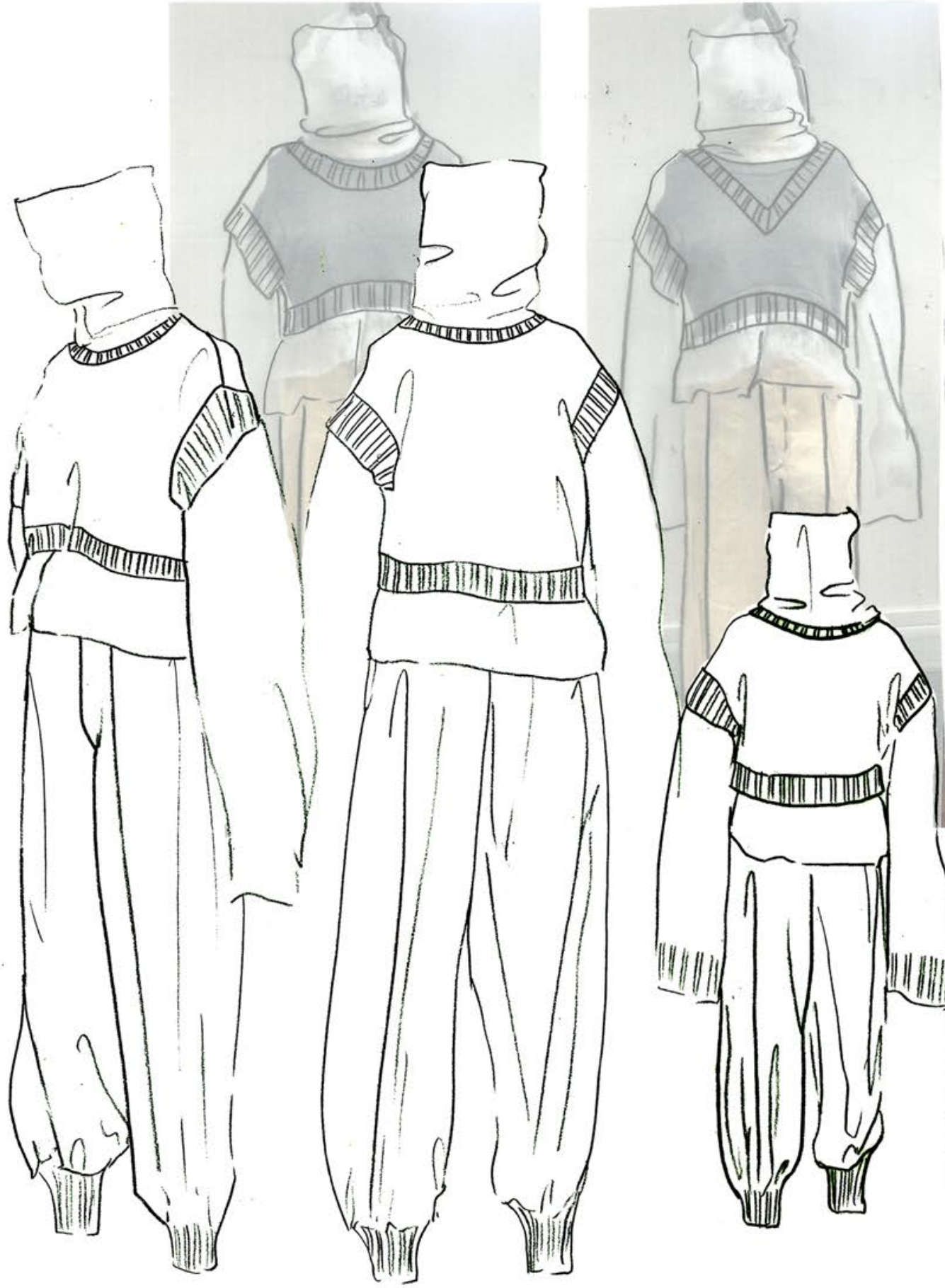





THE CROPPED GILET

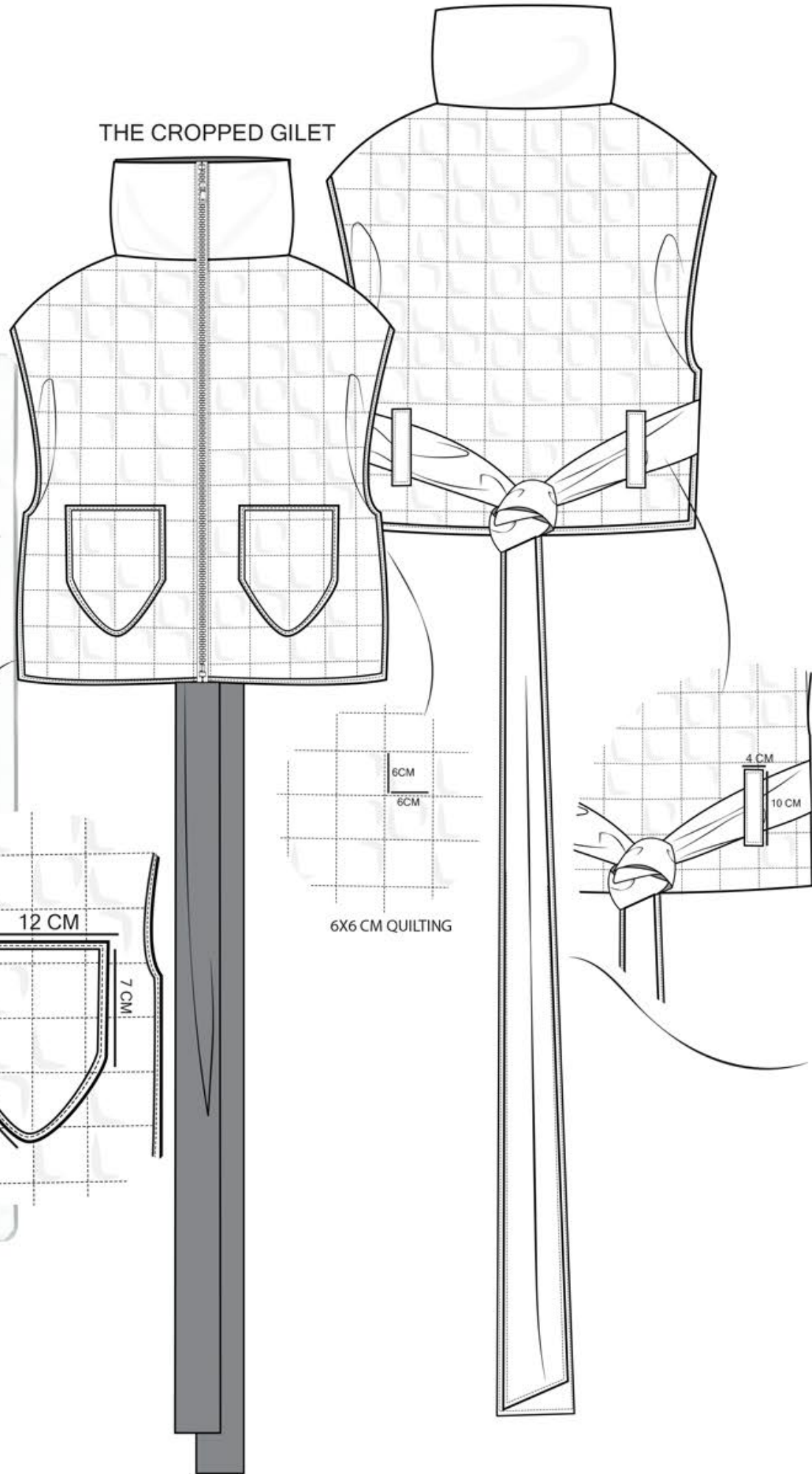

120 CM

10 CM



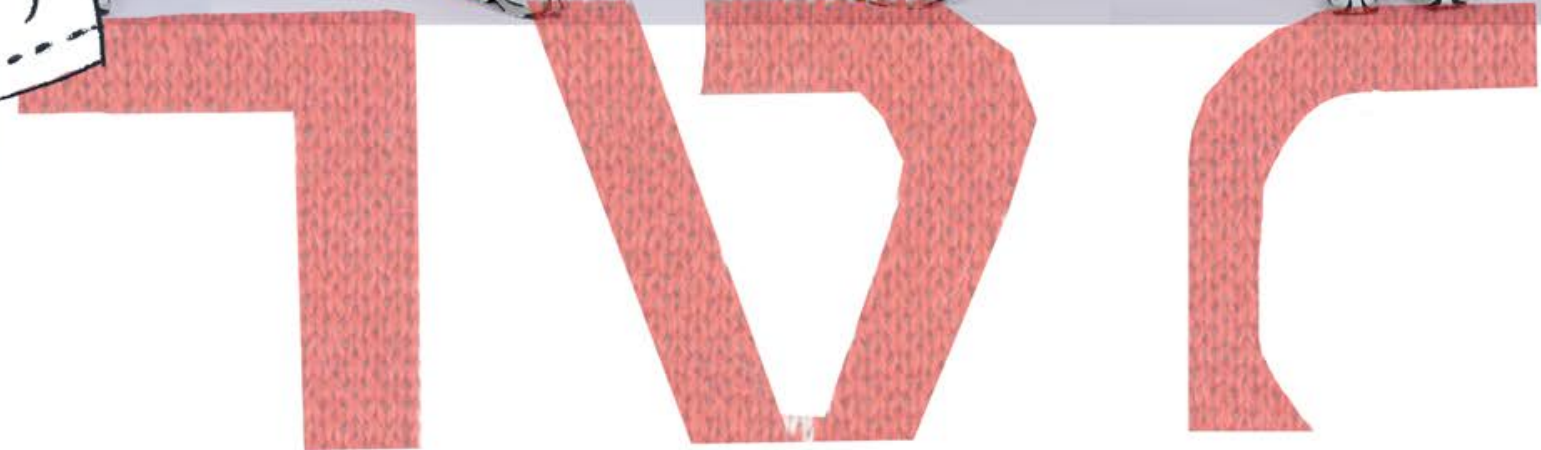

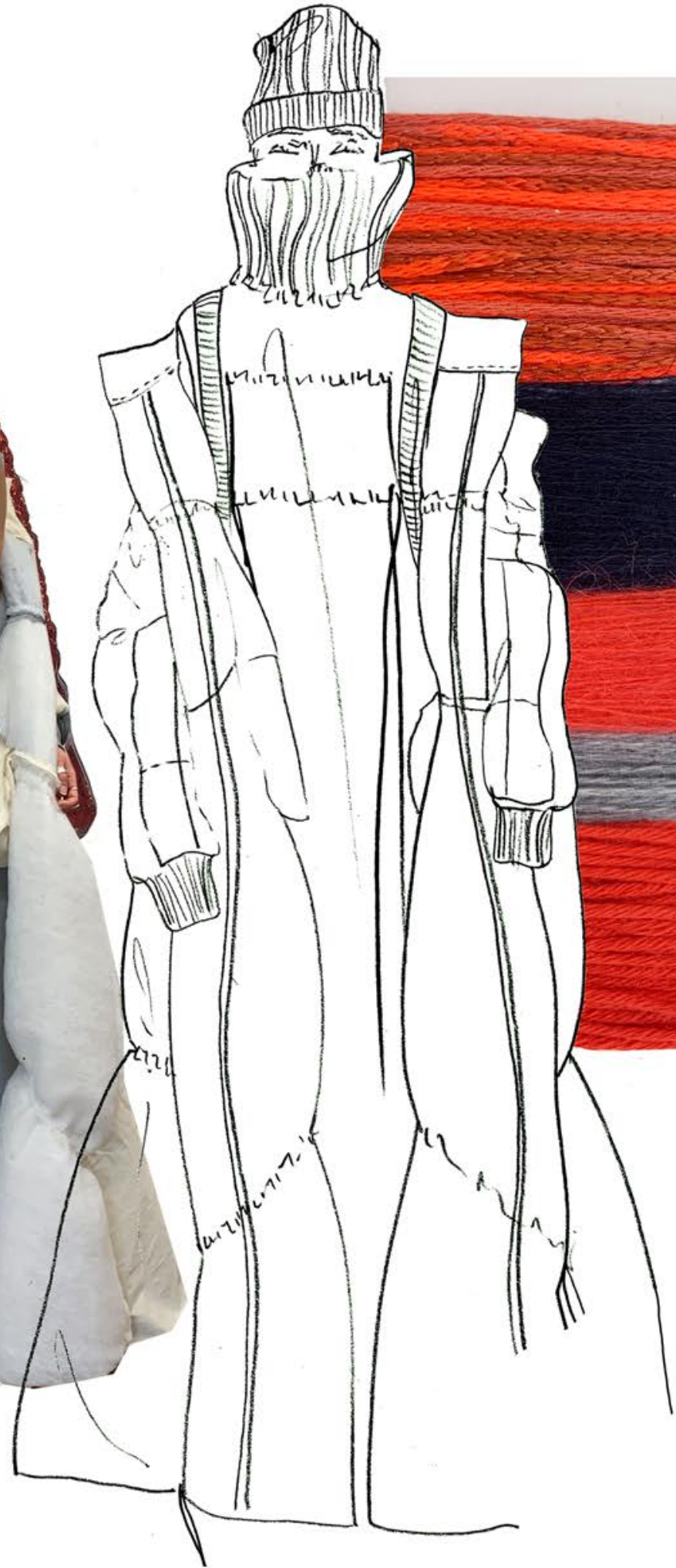

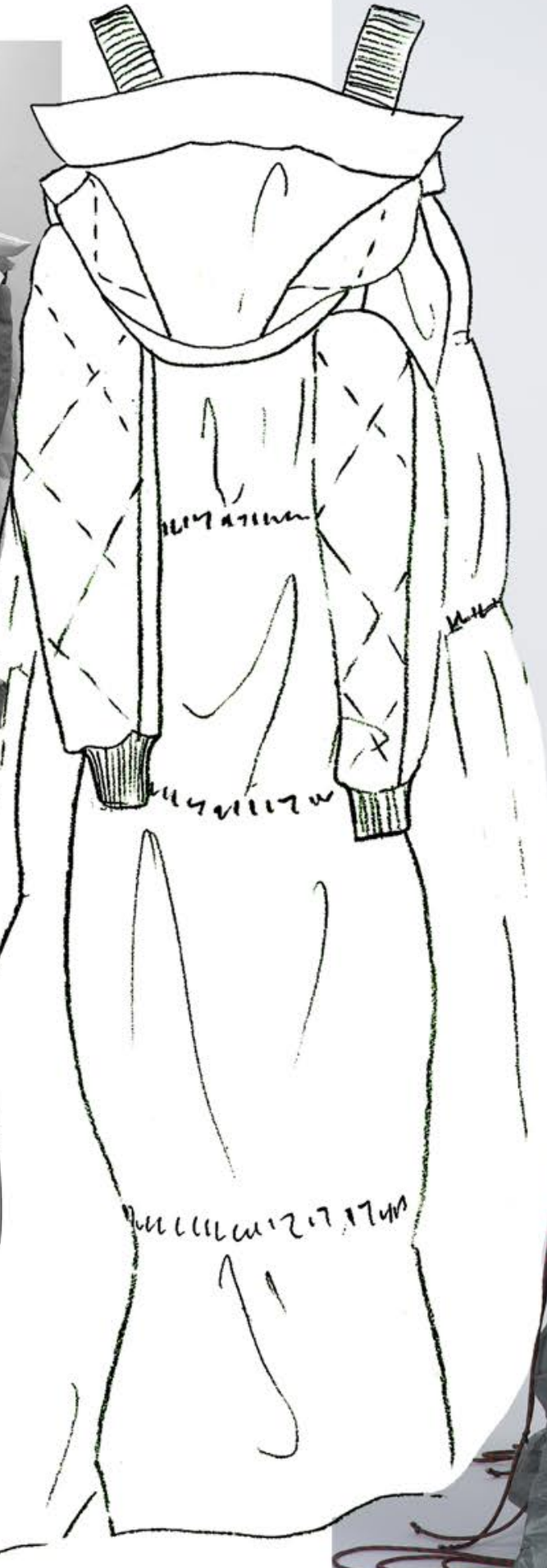
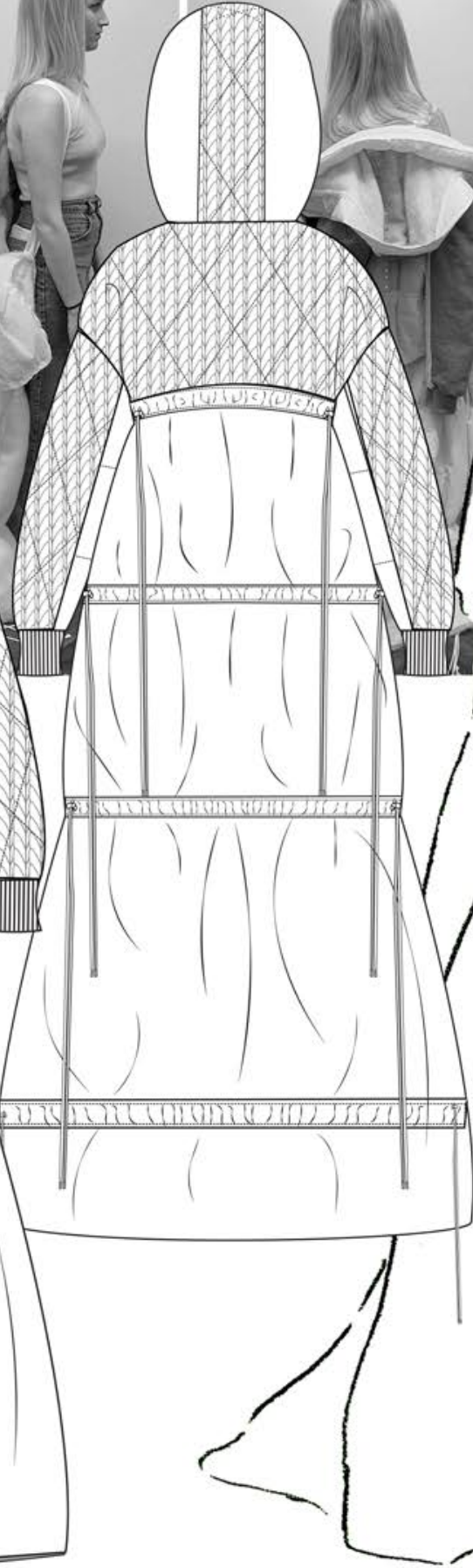
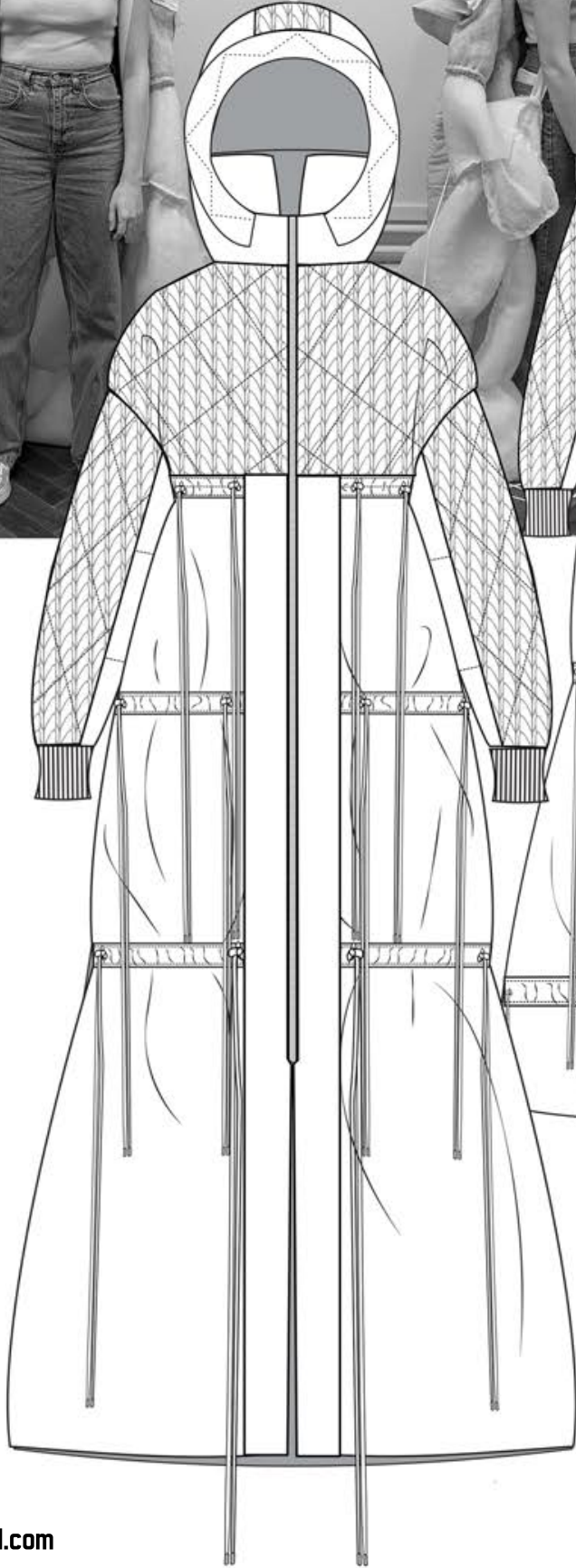
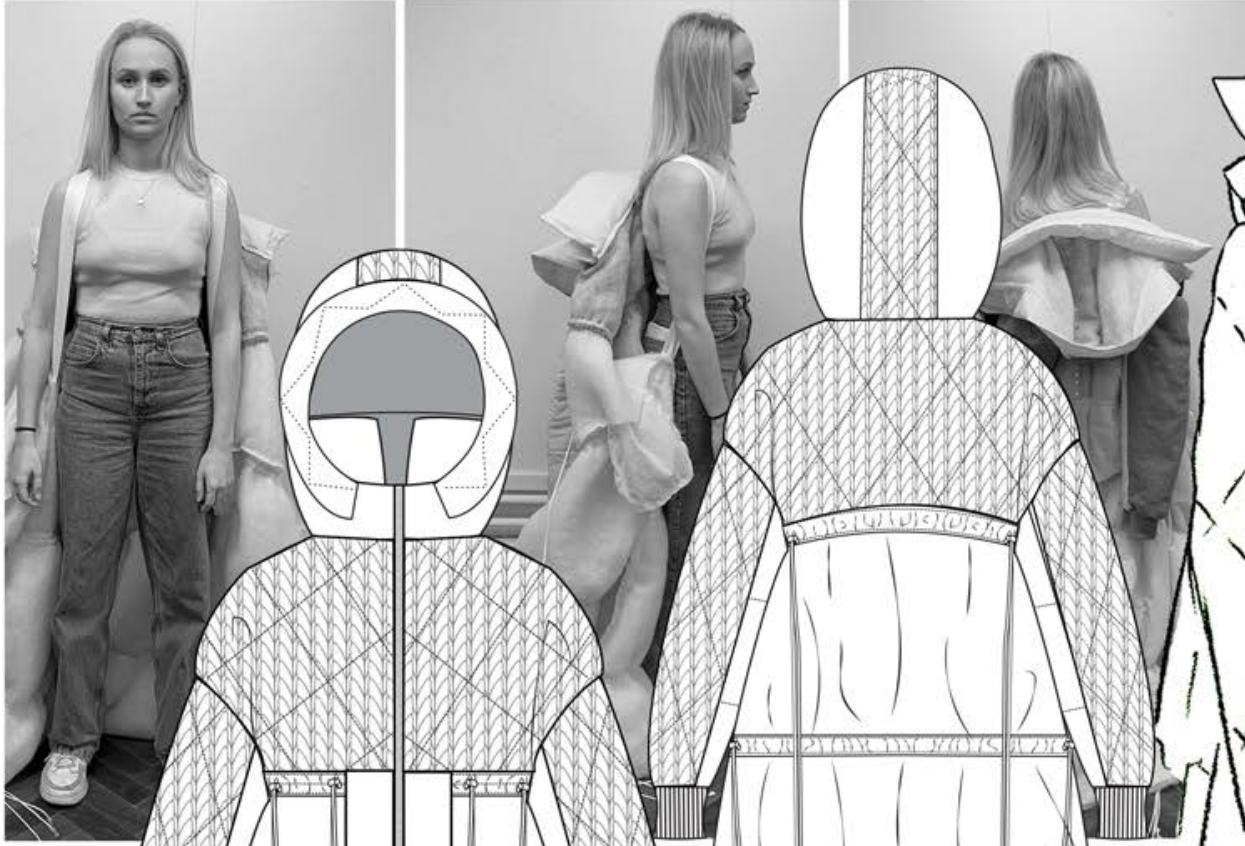



TECHNICAL JAQUARD KNITTED
ON THE SHEMA DIGITAL KNIT MACHINE
ZENGA BARUFFA CASHWOOL
NM 2/30 GREY MELANGE

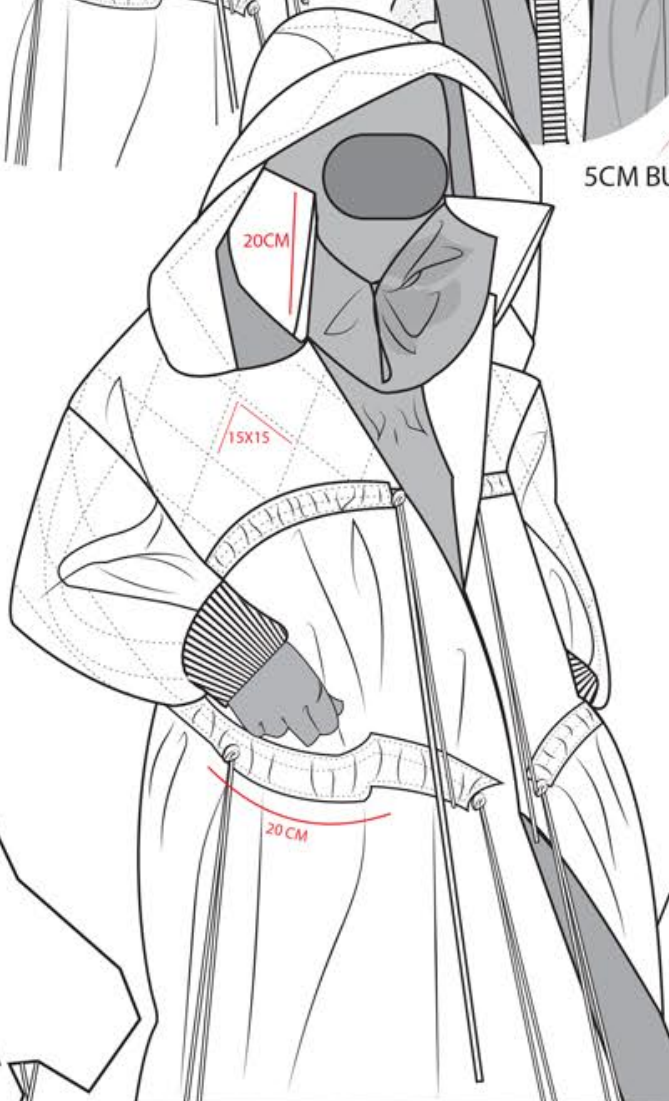
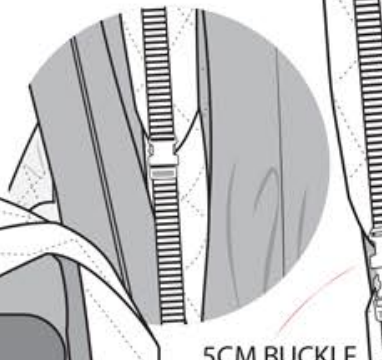
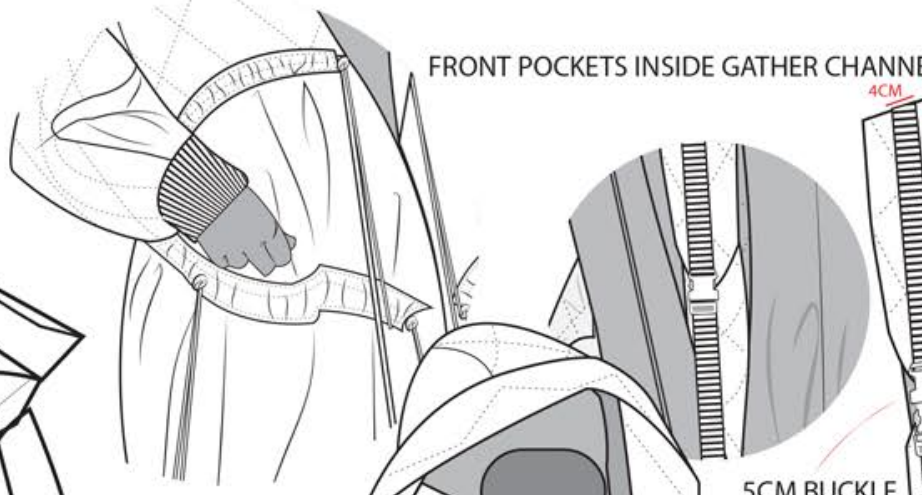

QUILTED BACK PACK STRAPS

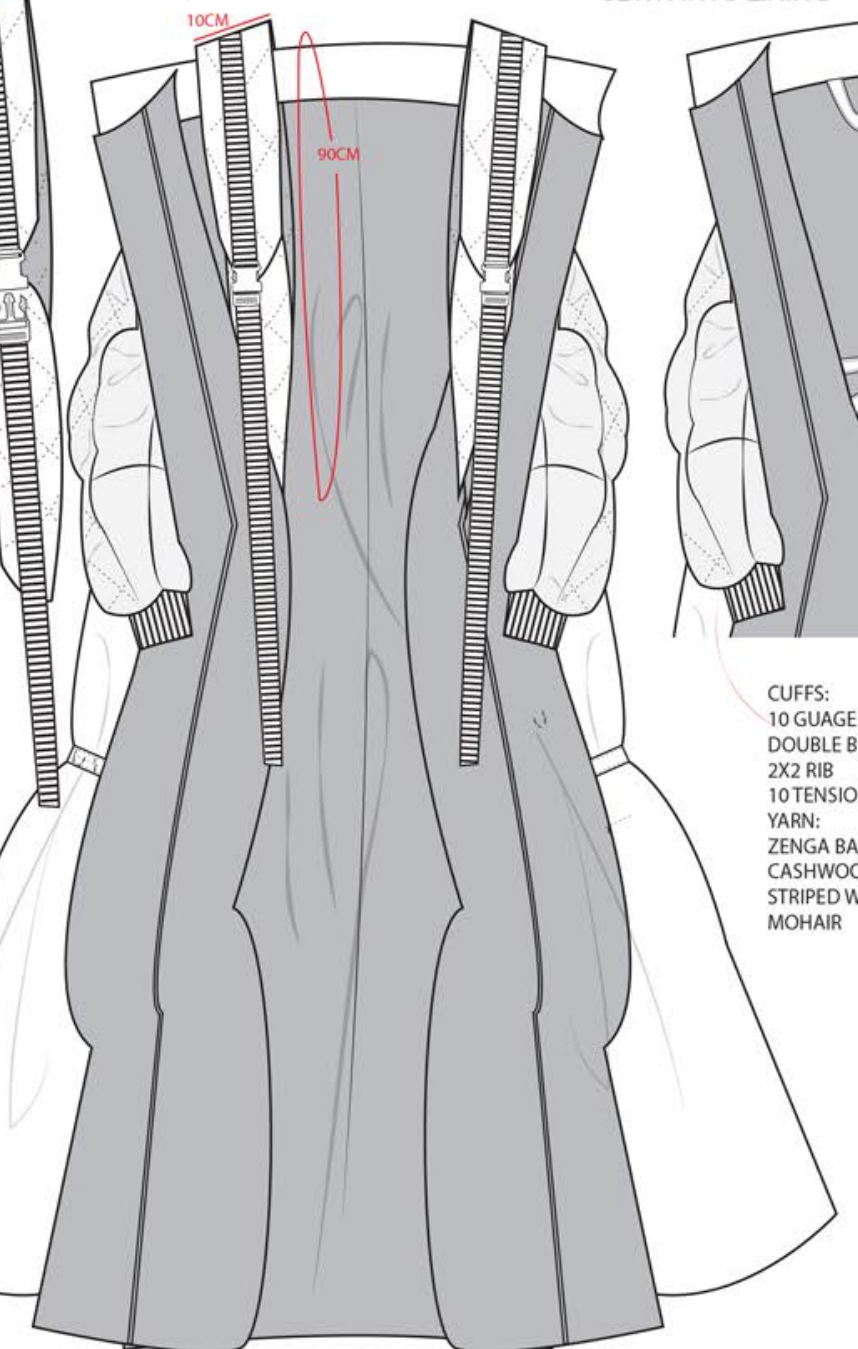

BELT LOOP STYLE STRAPS
SEWN INTO LINING

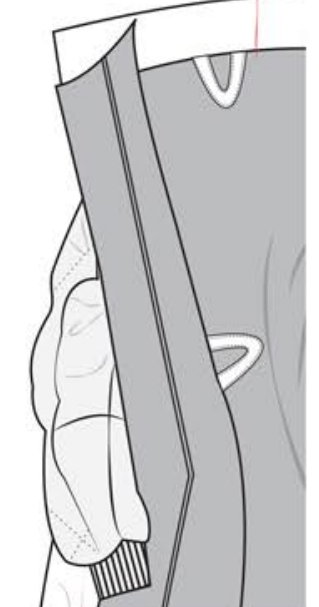

CUFFS:
10 GAUGE
DOUBLE BED
2X2 RIB
10 TENSION
YARN:
ZENGA BARUFFA
CASHWOOL
STRIPED WITH LINEAPIU
MOHAIR

